



This Computer program (including software design, programming structure, graphics, manual, and on-line help) was created by the pcaStructurePoint, the Engineering Software Group of the Portland Cement Association.

Winsoft Software Inc. of Ottawa, Ontario, Canada, assisted in the development of the graphical interface.

While the Portland Cement Association has taken every precaution to utilize the existing state-of-the-art and to assure the correctness of the analytical solution techniques used in this program, the responsibilities for modeling the structure, inputting data, applying engineering judgment to evaluate the output, and implementing engineering drawings remain with the structural engineer of record. Accordingly, Portland Cement Association does and must disclaim any and all responsibility for defects or failures of structures in connection with which this program is used.

© 1988 – 2004 Portland Cement Association. All Rights Reserved.

pcaMats and PCA-Mats are Trademarks of the Portland Cement Association

Microsoft and Windows are registered trademarks of the Microsoft Corporation.

License Agreements

PORTLAND CEMENT ASSOCIATION EVALUATION SOFTWARE LICENSE AGREEMENT

BY CLICKING THE "I AGREE" ICON BELOW, OR BY INSTALLING, COPYING, OR OTHERWISE USING THE SOFTWARE OR USER DOCUMENTATION, YOU AGREE TO BE BOUND BY THE TERMS OF THIS AGREEMENT, INCLUDING, BUT NOT LIMITED TO, THE WARRANTY DISCLAIMERS, LIMITATIONS OF LIABILITY AND TERMINATION PROVISIONS BELOW. IF YOU DO NOT AGREE TO THE TERMS OF THIS AGREEMENT, DO NOT INSTALL OR USE THE SOFTWARE OR USER DOCUMENTATION, EXIT THIS APPLICATION NOW AND RETURN THE SOFTWARE AND USER DOCUMENTATION TO PCA.

PORTLAND CEMENT ASSOCIATION, 5420 OLD ORCHARD ROAD, SKOKIE, ILLINOIS 60077 (HEREAFTER PCA), GRANTS THE CUSTOMER A PERSONAL, NONEXCLUSIVE, LIMITED, NONTRANSFERABLE LICENSE TO USE THIS SOFTWARE AND USER DOCUMENTATION SOLELY FOR TRIAL AND EVALUATION PURPOSES ONLY IN ACCORDANCE WITH THE TERMS AND CONDITIONS OF THIS AGREEMENT. SOFTWARE AND USER DOCUMENTATION IS SUPPLIED TO CUSTOMER EITHER BY PCA DIRECTLY OR THROUGH AN AUTHORIZED DEALER OF PCA (HEREAFTER DEALER).

WHILE PCA HAS TAKEN PRECAUTIONS TO ASSURE THE CORRECTNESS OF THE ANALYTICAL SOLUTION AND DESIGN TECHNIQUES USED IN THIS SOFTWARE, IT CANNOT AND DOES NOT GUARANTEE ITS PERFORMANCE, NOR CAN IT OR DOES IT BEAR ANY RESPONSIBILITY FOR DEFECTS OR FAILURES IN STRUCTURES IN CONNECTION WITH WHICH THIS SOFTWARE MAY BE USED. DEALER (IF ANY) HAS NOT PARTICIPATED IN THE DESIGN OR DEVELOPMENT OF THIS SOFTWARE AND NEITHER GUARANTEES THE PERFORMANCE OF THE SOFTWARE NOR BEARS ANY RESPONSIBILITY FOR DEFECTS OR FAILURES IN STRUCTURES IN CONNECTION WITH WHICH THIS SOFTWARE IS USED.

PCA AND DEALER (IF ANY) EXPRESSLY DISCLAIM ANY WARRANTY THAT: (A) THE FUNCTIONS CONTAINED IN THE SOFTWARE WILL MEET THE REQUIREMENTS OF CUSTOMER OR OPERATE IN COMBINATIONS THAT MAY BE SELECTED FOR USE BY CUSTOMER; (B) THE OPERATION OF THE SOFTWARE WILL BE FREE OF ALL "BUGS" OR PROGRAM ERRORS; OR (C) THE SOFTWARE CONFORMS TO ANY PERFORMANCE SPECIFICATIONS. CUSTOMER ACKNOWLEDGES THAT PCA IS UNDER NO OBLIGATION TO PROVIDE ANY SUPPORT, UPDATES, BUG FIXES OR ERROR CORRECTIONS TO OR FOR THE SOFTWARE OR USER DOCUMENTATION.

THE LIMITED WARRANTIES IN SECTION 6 HEREOF ARE IN LIEU OF ALL OTHER WARRANTIES, EXPRESS OR IMPLIED, INCLUDING, BUT NOT LIMITED TO, ANY IMPLIED WARRANTIES OF NON-INFRINGEMENT, MERCHANTABILITY OR FIT NESS FOR A PARTICULAR PURPOSE, EACH OF WHICH IS HEREBY DISCLAIMED. EXCEPT AS SET FORTH IN SECTION 6, THE SOFTWARE AND USER DOCUMENTATION ARE PROVIDED ON AN "AS-IS" BASIS.

IN NO EVENT SHALL PCA OR DEALER (IF ANY) BE LIABLE FOR: (A) LOSS OF PROFITS, DIRECT, INDIRECT, INCIDENTAL, SPECIAL, EXEMPLARY, PUNITIVE, CONSEQUENTIAL OR OTHER DAMAGES, EVEN IF PCA OR DEALER (IF ANY) HAS BEEN ADVISED OF THE POSSIBILITY OF SUCH DAMAGES; (B) ANY CLAIM AGAINST CUSTOMER BY ANY THIRD

PARTY; OR (C) ANY DAMAGES CAUSED BY (1) DELAY IN DELIVERY OF THE SOFTWARE OR USER DOCUMENTATION UNDER THIS AGREEMENT; (2) THE PERFORMANCE OR NON PERFORMANCE OF THE SOFTWARE; (3) RESULTS FROM USE OF THE SOFTWARE OR USER DOCUMENTATION, INCLUDING, WITHOUT LIMITATION, MISTAKES, ERRORS, INACCURACIES, FAILURES OR CUSTOMER'S INABILITY TO PROVIDE SERVICES TO THIRD PARTIES THROUGH USE OF THE SOFTWARE OR USER DOCUMENTATION; (4) CUSTOMER'S FAILURE TO PERFORM CUSTOMER'S RESPONSIBILITIES; (5) PCA NOT PROVIDING UPDATES, BUG FIXES OR CORRECTIONS TO OR FOR ANY OF THE SOFTWARE OR USER DOCUMENTATION; (6) LABOR, EXPENSE OR MATERIALS NECESSARY TO REPAIR DAMAGE TO THE SOFTWARE OR USER DOCUMENTATION CAUSED BY (a) ACCIDENT, (b) NEGLIGENCE OR ABUSE BY CUSTOMER, (c) ACTS OF THIRD PERSONS INCLUDING, BUT NOT LIMITED TO, INSTALLATION, REPAIR, MAINTENANCE OR OTHER CORRECTIVE WORK RELATED TO ANY EQUIPMENT BEING USED, (d) CAUSES EXTERNAL TO THE SOFTWARE SUCH AS POWER FLUCTUATION AND FAILURES, OR (e) FLOODS, WINDSTORMS OR OTHER ACTS OF GOD. MOREOVER, IN NO EVENT SHALL PCA BE LIABLE FOR WARRANTIES, GUARANTEES, REPRESENTATIONS OR ANY OTHER UNDERSTANDINGS BETWEEN CUSTOMER AND DEALER (IF ANY) RELATING TO THE SOFTWARE OR USER DOCUMENTATION.

THIS AGREEMENT CONSTITUTES THE ENTIRE AND EXCLUSIVE AGREEMENT BETWEEN CUSTOMER AND PCA AND DEALER (IF ANY) WITH RESPECT TO THE SOFTWARE AND USER DOCUMENTATION TO BE FURNISHED HEREUNDER. IT IS A FINAL EXPRESSION OF THAT AGREEMENT AND UNDERSTANDING. IT SUPERSEDES ALL PRIOR COMMUNICATIONS BETWEEN THE PARTIES (INCLUDING ANY EVALUATION LICENSE AND ALL ORAL AND WRITTEN PROPOSALS). ORAL STATEMENTS MADE BY PCA'S OR DEALER'S (IF ANY) REPRESENTATIVES ABOUT THE SOFTWARE OR USER DOCUMENTATION DO NOT CONSTITUTE REPRESENTATIONS OR WARRANTIES, SHALL NOT BE RELIED ON BY CUSTOMER, AND ARE NOT PART OF THIS AGREEMENT.

I. LICENSE RESTRICTIONS

- (a) Except as expressly provided in this Agreement or as otherwise authorized in writing by PCA, Customer has no right to: (1) use, print, copy, display, reverse assemble, reverse engineer, translate or decompile the Software or User Documentation in whole or in part; (2) disclose, publish, release, sublicense or transfer to another person any Software or User Documentation; (3) reproduce the Software or User Documentation for the use or benefit of anyone other than Customer; or (4) modify any Software or User Documentation. All rights to the Software and User Documentation not expressly granted to Customer hereunder are retained by PCA. All copyrights and other proprietary rights except as expressed elsewhere in the Software or User Documentation and legal title thereto shall remain in PCA. Customer may use the Software at only one designated workstation at Customer's site at any given time. Customer may not transmit the Software electronically to any other workstation, computer, node or terminal device whether via a local area network, a wide area network, telecommunications transmission, the Internet or other means now known or hereafter created without prior written permission by PCA.

- (b) Customer acknowledges that this is a limited license for trial and evaluation purposes only. This limited license shall automatically terminate upon the earlier of: (1) ten executions of the Software on the computer on which it is installed; or (2) fifteen days after the installation of the Software. Thereafter, Customer may only use the Software and Documentation if it acquires a production license for the same.

2. TERM AND TERMINATION

- (a) This Agreement shall be in effect from the date Customer clicks the “I AGREE” icon below or installs, copies or otherwise uses the Software or User Documentation until: (1) it is terminated by Customer, by Dealer (if any) on behalf of Customer or PCA or by PCA as set forth herein; or (2) the limited trial and evaluation license terminates.
- (b) This Agreement may be terminated by PCA without cause upon 30 days' written notice or immediately upon notice to Customer if Customer breaches this Agreement or fails to comply with any of its terms or conditions. This Agreement may be terminated by Customer without cause at any time upon written notice to PCA.

3. BACKUP AND REPLACEMENT COPIES

Customer may make one copy of the Software for back-up and archival purposes only, provided PCA's copyright and other proprietary rights notices are included on such copy.

4. PROTECTION AND SECURITY

- (a) Customer shall not provide or otherwise make available any of the Software or User Documentation in any form to any person other than employees of Customer with the need to know, without PCA's written permission.
- (b) All Software and User Documentation in Customer's possession including, without limitation, translations, compilations, back-up, and partial copies is the property of PCA. Upon termination of this Agreement for any reason, Customer shall immediately destroy all Software and User Documentation, including all media, and destroy any Software that has been copied onto other magnetic storage devices. Upon PCA's request, Customer shall certify its compliance in writing with the foregoing to PCA.
- (c) Customer shall take appropriate action, by instruction, agreement or otherwise, with any persons permitted access to the Software or User Documentation, to enable Customer to satisfy its obligations under this Agreement with respect to use, copying, protection, and security of the same.
- (d) If PCA prevails in an action against Customer for breach of the provisions of this Section 4, Customer shall pay the reasonable attorneys' fees, costs, and expenses incurred by PCA in connection with such action in addition to any award of damages.

5. CUSTOMER'S RESPONSIBILITIES

The essential purpose of this Agreement is to provide Customer with limited use rights to the Software and User Documentation. Customer accepts full responsibility for: (a) selection of the Software and User Documentation to satisfy Customer's business needs and achieve Customer's intended results; (b) the use, set-up and installation of the Software and User Documentation; (c) all results obtained from use of the Software and User Documentation; and (d) the selection, use of, and results obtained from any other software, programming equipment or services used with the Software or User Documentation.

6. LIMITED WARRANTIES

PCA and Dealer (if any) warrants to Customer that: (a) PCA and Dealer (if any) has title to the Software and User Documentation and/or the right to grant Customer the rights granted hereunder;

(b) the Software and User Documentation provided hereunder is PCA's most current production version thereof; and (c) the copy of the Software provided hereunder is an accurate reproduction of the original from which it was made.

7. LIMITATION OF REMEDY

- (a) **PCA AND DEALER (IF ANY) HAS NO LIABILITY UNDER THIS AGREEMENT. CUSTOMER'S EXCLUSIVE REMEDY FOR DAMAGES DUE TO PERFORMANCE OR NONPERFORMANCE OF ANY SOFTWARE OR USER DOCUMENTATION, PCA, DEALER (IF ANY), OR ANY OTHER CAUSE WHATSOEVER, AND REGARDLESS OF THE FORM OF ACTION, WHETHER IN CONTRACT OR IN TORT, INCLUDING NEGLIGENCE, SHALL BE LIMITED TO CUSTOMER STOPPING ALL USE OF THE SOFTWARE AND USER DOCUMENTATION AND RETURNING THE SAME TO PCA.**
- (b) **NEITHER PCA NOR DEALER (IF ANY) IS AN INSURER WITH REGARD TO THE PERFORMANCE OF THE SOFTWARE OR USER DOCUMENTATION. THE TERMS OF THIS AGREEMENT, INCLUDING, BUT NOT LIMITED TO, THE LIMITED WARRANTIES, AND THE LIMITATION OF LIABILITY AND REMEDY, ARE A REFLECTION OF THE RISKS ASSUMED BY THE PARTIES. IN ORDER TO OBTAIN THE SOFTWARE AND USER DOCUMENTATION FROM PCA OR DEALER (IF ANY), CUSTOMER HEREBY ASSUMES THE RISKS FOR (1) ALL LIABILITIES DISCLAIMED BY PCA AND DEALER (IF ANY) ON THE FACE HEREOF; AND (2) ALL ACTUAL OR ALLEGED DAMAGES IN CONNECTION WITH THE USE OF THE SOFTWARE AND USER DOCUMENTATION. THE ESSENTIAL PURPOSE OF THE LIMITED REMEDY PROVIDED CUSTOMER HEREUNDER IS TO ALLOCATE THE RISKS AS PROVIDED ABOVE.**

8. U.S. GOVERNMENT RESTRICTED RIGHTS

This commercial computer software and commercial computer software documentation were developed exclusively at private expense by Portland Cement Association, 5420 Old Orchard Road, Skokie, Illinois, 60077. U.S. Government rights to use, modify, release, reproduce, perform, display or disclose this computer software and computer software documentation are subject to the restrictions of DFARS 227.7202-1(a) (June 1995) and DFARS 227.7202-3(a) (June 1995), or the Restricted Rights provisions of FAR 52.227-14 (June 1987) and FAR 52.227-19 (June 1987), as applicable.

9. GENERAL

- (a) No action arising out of any claimed breach of this Agreement or transactions under this Agreement may be brought by Customer more than two years after the cause of such action has arisen.
- (b) Customer may not assign, sell, sublicense or otherwise transfer this Agreement, the license granted herein or the Software or User Documentation by operation of law or otherwise without the prior written consent of PCA. Any attempt to do any of the foregoing without PCA's consent is void.
- (c) Customer acknowledges that the Software, User Documentation and other proprietary information and materials of PCA are unique and that, if Customer breaches this Agreement, PCA may not have an adequate remedy at law and PCA may enforce its rights hereunder by an action for

damages and/or injunctive or other equitable relief without the necessity of proving actual damage or posting a bond therefor.

- (D) THE RIGHTS AND OBLIGATIONS UNDER THIS AGREEMENT SHALL NOT BE GOVERNED BY THE UNITED NATIONS CONVENTION ON CONTRACTS FOR THE INTERNATIONAL SALE OF GOODS, THE APPLICATION OF WHICH IS EXPRESSLY EXCLUDED, BUT SUCH RIGHTS AND OBLIGATIONS SHALL INSTEAD BE GOVERNED BY THE LAWS OF THE STATE OF ILLINOIS, APPLICABLE TO CONTRACTS ENTERED INTO AND PERFORMED ENTIRELY WITHIN THE STATE OF ILLINOIS AND APPLICABLE FEDERAL (U.S.) LAWS. UCITA SHALL NOT APPLY TO THIS AGREEMENT.
- (E) THIS AGREEMENT SHALL BE TREATED AS THOUGH IT WERE EXECUTED IN THE COUNTY OF COOK, STATE OF ILLINOIS, AND WAS TO HAVE BEEN PERFORMED IN THE COUNTY OF COOK, STATE OF ILLINOIS. ANY ACTION RELATING TO THIS AGREEMENT SHALL BE INSTITUTED AND PROSECUTED IN A COURT LOCATED IN COOK COUNTY, ILLINOIS. CUSTOMER SPECIFICALLY CONSENTS TO EXTRATERRITORIAL SERVICE OF PROCESS.
- (f) Except as prohibited elsewhere in this Agreement, this Agreement shall be binding upon and inure to the benefit of the personal and legal representatives, permitted successors, and permitted assigns of the parties hereto.
- (g) All notices, demands, consents or requests that may be or are required to be given by any party to another party shall be in writing. All notices, demands, consents or requests given by the parties hereto shall be sent either by U.S. certified mail, postage prepaid or by an overnight international delivery service, addressed to the respective parties. Notices, demands, consents or requests served as set forth herein shall be deemed sufficiently served or given at the time of receipt thereof.
- (h) The various rights, options, elections, powers, and remedies of a party or parties to this Agreement shall be construed as cumulative and no one of them exclusive of any others or of any other legal or equitable remedy that said party or parties might otherwise have in the event of breach or default in the terms hereof. The exercise of one right or remedy by a party or parties shall not in any way impair its rights to any other right or remedy until all obligations imposed on a party or parties have been fully performed.
- (i) No waiver by Customer, PCA or Dealer (if any) of any breach, provision, or default by the other shall be deemed a waiver of any other breach, provision or default.
- (j) The parties hereto, and each of them, agree that the terms of this Agreement shall be given a neutral interpretation and any ambiguity or uncertainty herein should not be construed against any party hereto.
- (k) If any provision of this Agreement or portion thereof is held to be unenforceable or invalid by any court or competent jurisdiction, such decision shall not have the effect of invalidating or voiding the remainder of this Agreement, it being the intent and agreement of the parties that this Agreement shall be deemed amended by modifying such provision to the extent necessary to render it enforceable and valid while preserving its intent or, if such modification is not possible, by substituting therefor another provision that is enforceable and valid so as to materially effectuate the parties' intent.
- (l) Except as set forth herein, this Agreement may be modified or amended only by a written instrument signed by a duly authorized representative of PCA and Customer.

PORTLAND CEMENT ASSOCIATION SOFTWARE LICENSE AGREEMENT

BY CLICKING THE "I AGREE" BELOW, OR BY INSTALLING, COPYING, OR OTHERWISE USING THE SOFTWARE OR USER DOCUMENTATION, YOU AGREE TO BE BOUND BY THE TERMS OF THIS AGREEMENT, INCLUDING, BUT NOT LIMITED TO, THE WARRANTY DISCLAIMERS, LIMITATIONS OF LIABILITY AND TERMINATION PROVISIONS BELOW. IF YOU DO NOT AGREE TO THE TERMS OF THIS AGREEMENT, DO NOT INSTALL OR USE THE SOFTWARE OR USER DOCUMENTATION, EXIT THIS APPLICATION NOW AND RETURN THE SOFTWARE AND USER DOCUMENTATION TO PCA FOR A FULL REFUND WITHIN THIRTY DAYS AFTER YOUR RECEIPT OF THE SOFTWARE AND USER DOCUMENTATION.

PORTLAND CEMENT ASSOCIATION, 5420 OLD ORCHARD ROAD, SKOKIE, ILLINOIS 60077 (HEREAFTER PCA), GRANTS THE CUSTOMER A PERSONAL, NONEXCLUSIVE, LIMITED, NONTRANSFERABLE LICENSE TO USE THIS SOFTWARE AND USER DOCUMENTATION IN ACCORDANCE WITH THE TERMS AND CONDITIONS OF THIS AGREEMENT. SOFTWARE AND USER DOCUMENTATION IS SUPPLIED TO CUSTOMER EITHER BY PCA DIRECTLY OR THROUGH AN AUTHORIZED DEALER OF PCA (HEREAFTER DEALER).

WHILE PCA HAS TAKEN PRECAUTIONS TO ASSURE THE CORRECTNESS OF THE ANALYTICAL SOLUTION AND DESIGN TECHNIQUES USED IN THIS SOFTWARE, IT CANNOT AND DOES NOT GUARANTEE ITS PERFORMANCE, NOR CAN IT OR DOES IT BEAR ANY RESPONSIBILITY FOR DEFECTS OR FAILURES IN STRUCTURES IN CONNECTION WITH WHICH THIS SOFTWARE IS USED. DEALER (IF ANY) HAS NOT PARTICIPATED IN THE DESIGN OR DEVELOPMENT OF THIS SOFTWARE AND NEITHER GUARANTEES THE PERFORMANCE OF THE SOFTWARE NOR BEARS ANY RESPONSIBILITY FOR DEFECTS OR FAILURES IN STRUCTURES IN CONNECTION WITH WHICH THIS SOFTWARE IS USED.

PCA AND DEALER (IF ANY) EXPRESSLY DISCLAIM ANY WARRANTY THAT: (A) THE FUNCTIONS CONTAINED IN THE SOFTWARE WILL MEET THE REQUIREMENTS OF CUSTOMER OR OPERATE IN COMBINATIONS THAT MAY BE SELECTED FOR USE BY CUSTOMER; (B) THE OPERATION OF THE SOFTWARE WILL BE FREE OF ALL "BUGS" OR PROGRAM ERRORS; OR (C) THE SOFTWARE CONFORMS TO ANY PERFORMANCE SPECIFICATIONS. CUSTOMER ACKNOWLEDGES THAT PCA IS UNDER NO OBLIGATION TO PROVIDE ANY SUPPORT, UPDATES, BUG FIXES OR ERROR CORRECTIONS TO OR FOR THE SOFTWARE OR USER DOCUMENTATION.

THE LIMITED WARRANTIES IN SECTION 7 HEREOF ARE IN LIEU OF ALL OTHER WARRANTIES, EXPRESS OR IMPLIED, INCLUDING, BUT NOT LIMITED TO, ANY IMPLIED WARRANTIES OF NON-INFRINGEMENT, MERCHANTABILITY OR FITNESS FOR A PARTICULAR PURPOSE, EACH OF WHICH IS HEREBY DISCLAIMED. EXCEPT AS SET FORTH IN SECTION 7, THE SOFTWARE AND USER DOCUMENTATION ARE PROVIDED ON AN "AS-IS" BASIS.

IN NO EVENT SHALL PCA OR DEALER (IF ANY) BE LIABLE FOR: (A) LOSS OF PROFITS, INDIRECT, INCIDENTAL, SPECIAL, EXEMPLARY, PUNITIVE, CONSEQUENTIAL OR OTHER DAMAGES, EVEN IF PCA OR DEALER (IF ANY) HAS BEEN ADVISED OF THE POSSIBILITY OF SUCH DAMAGES; (B) ANY CLAIM AGAINST CUSTOMER BY ANY THIRD PARTY EXCEPT AS PROVIDED IN SECTION 8 ENTITLED "INFRINGEMENT"; OR (C) ANY DAMAGES CAUSED BY (1) DELAY IN DELIVERY OF THE SOFTWARE OR USER DOCUMENTATION UNDER THIS AGREEMENT; (2) THE PERFORMANCE OR NONPERFORMANCE OF THE SOFTWARE; (3) RESULTS FROM USE OF THE SOFTWARE OR USER DOCUMENTATION, INCLUDING, WITHOUT

LIMITATION, MISTAKES, ERRORS, INACCURACIES, FAILURES OR CUSTOMER'S INABILITY TO PROVIDE SERVICES TO THIRD PARTIES THROUGH USE OF THE SOFTWARE OR USER DOCUMENTATION; (4) CUSTOMER'S FAILURE TO PERFORM CUSTOMER'S RESPONSIBILITIES; (5) PCA NOT PROVIDING UPDATES, BUG FIXES OR CORRECTIONS TO OR FOR ANY OF THE SOFTWARE OR USER DOCUMENTATION; (6) LABOR, EXPENSE OR MATERIALS NECESSARY TO REPAIR DAMAGE TO THE SOFTWARE OR USER DOCUMENTATION CAUSED BY (a) ACCIDENT, (b) NEGLIGENCE OR ABUSE BY CUSTOMER, (c) ACTS OF THIRD PERSONS INCLUDING, BUT NOT LIMITED TO, INSTALLATION, REPAIR, MAINTENANCE OR OTHER CORRECTIVE WORK RELATED TO ANY EQUIPMENT BEING USED, (d) CAUSES EXTERNAL TO THE SOFTWARE SUCH AS POWER FLUCTUATION AND FAILURES, OR (e) FLOODS, WINDSTORMS OR OTHER ACTS OF GOD. MOREOVER, IN NO EVENT SHALL PCA BE LIABLE FOR WARRANTIES, GUARANTEES, REPRESENTATIONS OR ANY OTHER UNDERSTANDINGS BETWEEN CUSTOMER AND DEALER (IF ANY) RELATING TO THE SOFTWARE OR USER DOCUMENTATION.

THIS AGREEMENT CONSTITUTES THE ENTIRE AND EXCLUSIVE AGREEMENT BETWEEN CUSTOMER AND PCA AND DEALER (IF ANY) WITH RESPECT TO THE SOFTWARE AND USER DOCUMENTATION TO BE FURNISHED HEREUNDER. IT IS A FINAL EXPRESSION OF THAT AGREEMENT AND UNDERSTANDING. IT SUPERSEDES ALL PRIOR COMMUNICATIONS BETWEEN THE PARTIES (INCLUDING ANY EVALUATION LICENSE AND ALL ORAL AND WRITTEN PROPOSALS). ORAL STATEMENTS MADE BY PCA'S OR DEALER'S (IF ANY) REPRESENTATIVES ABOUT THE SOFTWARE OR USER DOCUMENTATION DO NOT CONSTITUTE REPRESENTATIONS OR WARRANTIES, SHALL NOT BE RELIED ON BY CUSTOMER, AND ARE NOT PART OF THIS AGREEMENT.

I. LICENSE RESTRICTIONS

- (a) Except as expressly provided in this Agreement or as otherwise authorized in writing by PCA, Customer has no right to: (1) use, print, copy, display, reverse assemble, reverse engineer, translate or decompile the Software or User Documentation in whole or in part; (2) disclose, publish, release, sublicense or transfer to another person any Software or User Documentation; (3) reproduce the Software or User Documentation for the use or benefit of anyone other than Customer; or (4) modify any Software or User Documentation. All rights to the Software and User Documentation not expressly granted to Customer hereunder are retained by PCA. All copyrights and other proprietary rights except as expressed elsewhere in the Software or User Documentation and legal title thereto shall remain in PCA. Customer may use the Software at only one designated workstation at Customer's site at any given time. Customer may not transmit the Software electronically to any other workstation, computer, node or terminal device whether via a local area network, a wide area network, telecommunications transmission, the Internet or other means now known or hereafter created without prior written permission by PCA.
- (B) **CUSTOMER ACKNOWLEDGES THAT THE REGISTRATION PROCESS FOR THE SOFTWARE RESULTS IN THE GENERATION OF A UNIQUE LICENSE KEY AND ACTIVATION CODE PAIR. ONCE THE LICENSE KEY AND ACTIVATION CODE ARE ENTERED DURING THE INSTALLATION PROCESS, THE SOFTWARE WILL ONLY WORK ON THE COMPUTER ON WHICH THE SOFTWARE IS INITIALLY INSTALLED. IF YOU NEED TO DEINSTALL THE SOFTWARE AND REINSTALL THE SOFTWARE ON A DIFFERENT COMPUTER, YOU MUST CONTACT PCA TO OBTAIN THE NECESSARY REINSTALLATION PROCEDURES.**

2. CHARGES AND PAYMENTS

All payments for the Software and User Documentation shall be made to either PCA or Dealer (if any), as appropriate.

3. TERM AND TERMINATION

- (a) This Agreement shall be in effect from the date Customer clicks the "I AGREE" below or installs, copies or otherwise uses the Software or User Documentation until it is terminated by Customer, by Dealer (if any) on behalf of Customer or PCA or by PCA as set forth herein.
- (b) This Agreement may be terminated by PCA without cause upon 30 days' written notice or immediately upon notice to Customer if Customer breaches this Agreement or fails to comply with any of its terms or conditions. This Agreement may be terminated by Customer without cause at any time upon written notice to PCA.

4. BACKUP AND REPLACEMENT COPIES

Customer may make one copy of the Software for back-up and archival purposes only, provided PCA's copyright and other proprietary rights notices are included on such copy.

5. PROTECTION AND SECURITY

- (a) Customer shall not provide or otherwise make available any of the Software or User Documentation in any form to any person other than employees of Customer with the need to know, without PCA's written permission.
- (b) All Software and User Documentation in Customer's possession including, without limitation, translations, compilations, back-up, and partial copies is the property of PCA. Upon termination of this Agreement for any reason, Customer shall immediately destroy all Software and User Documentation, including all media, and destroy any Software that has been copied onto other magnetic storage devices. Upon PCA's request, Customer shall certify its compliance in writing with the foregoing to PCA.
- (c) Customer shall take appropriate action, by instruction, agreement or otherwise, with any persons permitted access to the Software or User Documentation, to enable Customer to satisfy its obligations under this Agreement with respect to use, copying, protection, and security of the same.
- (d) If PCA prevails in an action against Customer for breach of the provisions of this Section 5, Customer shall pay the reasonable attorneys' fees, costs, and expenses incurred by PCA in connection with such action in addition to any award of damages.

6. CUSTOMER'S RESPONSIBILITIES

The essential purpose of this Agreement is to provide Customer with limited use rights to the Software and User Documentation. Customer accepts full responsibility for: (a) selection of the Software and User Documentation to satisfy Customer's business needs and achieve Customer's intended results; (b) the use, set-up and installation of the Software and User Documentation; (c) all results obtained from use of the Software and User Documentation; and (d) the selection, use of, and results obtained from any other software, programming equipment or services used with the Software or User Documentation.

7. LIMITED WARRANTIES

PCA and Dealer (if any) warrants to Customer that: (a) PCA and Dealer (if any) has title to the Software and User Documentation and/or the right to grant Customer the rights granted hereunder; (b) the Software and User Documentation provided hereunder is PCA's most current production version thereof; and (c) the copy of the Software provided hereunder is an accurate reproduction of the original from which it was made.

8. INFRINGEMENT

(a) PCA shall defend Customer against a claim that the Software or User Documentation furnished and used within the scope of the license granted hereunder infringes a U.S. patent or U.S. registered copyright of any third party that was issued or registered, as applicable, as of the date Customer clicked the "I AGREE" below or installed, copied or otherwise began using the Software or User Documentation, and PCA shall pay resulting costs, damages, and attorneys' fees finally awarded, subject to the limitation of liability set forth in Section 9 entitled "Limitation of Remedy," provided that:

1. Customer promptly notifies PCA in writing of the claim.

2. PCA has sole control of the defense and all related settlement negotiations.

3. If such claim has occurred or in PCA's opinion is likely to occur, Customer shall permit PCA at its sole option and expense either to procure for Customer the right to continue using the Software or User Documentation or to replace or modify the same so that it becomes noninfringing. If neither of the foregoing alternatives is reasonably available in PCA's sole judgment, Customer shall, on one month's written notice from PCA, return to PCA the Software and User Documentation and all copies thereof.

(b) PCA shall have no obligation to defend Customer or to pay costs, damages or attorneys' fees for any claim based upon (1) use of other than a current unaltered release of the Software or User Documentation, or (2) the combination, operation or use of any Software or User Documentation furnished hereunder with any other software, documentation or data if such infringement would have been avoided but for the combination, operation or use of the Software or User Documentation with other software, documentation or data.

(c) The foregoing states the entire obligation of PCA and Customer's sole remedy with respect to infringement matters relating to the Software and User Documentation.

9. LIMITATION OF REMEDY

(a) PCA'S AND DEALER'S (IF ANY) ENTIRE LIABILITY AND CUSTOMER'S EXCLUSIVE REMEDY FOR DAMAGES DUE TO PERFORMANCE OR NONPERFORMANCE OF ANY SOFTWARE OR USER DOCUMENTATION, PCA, DEALER (IF ANY), OR ANY OTHER CAUSE WHATSOEVER, AND REGARDLESS OF THE FORM OF ACTION, WHETHER IN CONTRACT OR IN TORT, INCLUDING NEGLIGENCE, SHALL BE LIMITED TO THE AMOUNT PAID TO PCA OR DEALER (IF ANY) FOR THE SOFTWARE AND USER DOCUMENTATION.

(b) NEITHER PCA NOR DEALER (IF ANY) IS AN INSURER WITH REGARD TO THE PERFORMANCE OF THE SOFTWARE OR USER DOCUMENTATION. THE TERMS OF THIS AGREEMENT, INCLUDING, BUT NOT LIMITED TO, THE LIMITED WARRANTIES, AND THE LIMITATION OF LIABILITY AND REMEDY, ARE A REFLECTION OF THE RISKS ASSUMED BY THE PARTIES. IN ORDER TO OBTAIN THE SOFTWARE AND USER DOCUMENTATION FROM PCA OR DEALER (IF ANY), CUSTOMER HEREBY ASSUMES THE RISKS FOR (1) ALL LIABILITIES DISCLAIMED BY PCA AND DEALER (IF ANY) ON THE FACE HEREOF; AND (2) ALL ACTUAL OR ALLEGED DAMAGES IN EXCESS OF THE AMOUNT OF THE LIMITED REMEDY

PROVIDED HEREUNDER. THE ESSENTIAL PURPOSE OF THE LIMITED REMEDY PROVIDED CUSTOMER HEREUNDER IS TO ALLOCATE THE RISKS AS PROVIDED ABOVE.

10. U.S. GOVERNMENT RESTRICTED RIGHTS

This commercial computer software and commercial computer software documentation were developed exclusively at private expense by Portland Cement Association, 5420 Old Orchard Road, Skokie, Illinois 60077. U.S. Government rights to use, modify, release, reproduce, perform, display or disclose this computer software and computer software documentation are subject to the restrictions of DFARS 227.7202-1(a) (June 1995) and DFARS 227.7202-3(a) (June 1995), or the Restricted Rights provisions of FAR 52.227-14 (June 1987) and FAR 52.227-19 (June 1987), as applicable.

11. GENERAL

- (a) No action arising out of any claimed breach of this Agreement or transactions under this Agreement may be brought by Customer more than two years after the cause of such action has arisen.
- (b) Customer may not assign, sell, sublicense or otherwise transfer this Agreement, the license granted herein or the Software or User Documentation by operation of law or otherwise without the prior written consent of PCA. Any attempt to do any of the foregoing without PCA's consent is void.
- (c) Customer acknowledges that the Software, User Documentation and other proprietary information and materials of PCA are unique and that, if Customer breaches this Agreement, PCA may not have an adequate remedy at law and PCA may enforce its rights hereunder by an action for damages and/or injunctive or other equitable relief without the necessity of proving actual damage or posting a bond therefor.
- (D) THE RIGHTS AND OBLIGATIONS UNDER THIS AGREEMENT SHALL NOT BE GOVERNED BY THE UNITED NATIONS CONVENTION ON CONTRACTS FOR THE INTERNATIONAL SALE OF GOODS, THE APPLICATION OF WHICH IS EXPRESSLY EXCLUDED, BUT SUCH RIGHTS AND OBLIGATIONS SHALL INSTEAD BE GOVERNED BY THE LAWS OF THE STATE OF ILLINOIS, APPLICABLE TO CONTRACTS ENTERED INTO AND PERFORMED ENTIRELY WITHIN THE STATE OF ILLINOIS AND APPLICABLE FEDERAL (U.S.) LAWS. UCITA SHALL NOT APPLY TO THIS AGREEMENT.
- (E) THIS AGREEMENT SHALL BE TREATED AS THOUGH IT WERE EXECUTED IN THE COUNTY OF COOK, STATE OF ILLINOIS, AND WAS TO HAVE BEEN PERFORMED IN THE COUNTY OF COOK, STATE OF ILLINOIS. ANY ACTION RELATING TO THIS AGREEMENT SHALL BE INSTITUTED AND PROSECUTED IN A COURT LOCATED IN COOK COUNTY, ILLINOIS. CUSTOMER SPECIFICALLY CONSENTS TO EXTRATERRITORIAL SERVICE OF PROCESS.
- (f) Except as prohibited elsewhere in this Agreement, this Agreement shall be binding upon and inure to the benefit of the personal and legal representatives, permitted successors, and permitted assigns of the parties hereto.

- (g) All notices, demands, consents or requests that may be or are required to be given by any party to another party shall be in writing. All notices, demands, consents or requests given by the parties hereto shall be sent either by U.S. certified mail, postage prepaid or by an overnight international delivery service, addressed to the respective parties. Notices, demands, consents or requests served as set forth herein shall be deemed sufficiently served or given at the time of receipt thereof.
- (h) The various rights, options, elections, powers, and remedies of a party or parties to this Agreement shall be construed as cumulative and no one of them exclusive of any others or of any other legal or equitable remedy that said party or parties might otherwise have in the event of breach or default in the terms hereof. The exercise of one right or remedy by a party or parties shall not in any way impair its rights to any other right or remedy until all obligations imposed on a party or parties have been fully performed.
- (i) No waiver by Customer, PCA or Dealer (if any) of any breach, provision, or default by the other shall be deemed a waiver of any other breach, provision or default.
- (j) The parties hereto, and each of them, agree that the terms of this Agreement shall be given a neutral interpretation and any ambiguity or uncertainty herein should not be construed against any party hereto.
- (k) If any provision of this Agreement or portion thereof is held to be unenforceable or invalid by any court or competent jurisdiction, such decision shall not have the effect of invalidating or voiding the remainder of this Agreement, it being the intent and agreement of the parties that this Agreement shall be deemed amended by modifying such provision to the extent necessary to render it enforceable and valid while preserving its intent or, if such modification is not possible, by substituting therefor another provision that is enforceable and valid so as to materially effectuate the parties' intent.

Except as set forth herein, this Agreement may be modified or amended only by a written instrument signed by a duly authorized representative of PCA and Customer.

Table of Contents

License Agreements	iii
Chapter 1. Introduction	1-1
Terms	1-1
Conventions	1-2
System requirements	1-2
Minimum Requirements	1-2
Recommended Options	1-3
Program Capacity	1-3
Installing pcaMats	1-4
Purchasing and Licensing Process	1-8
Licensing Model	1-8
Evaluation Mode	1-9
How to Purchase	1-9
Licensing Activation	1-9
Activation by Phone	1-12
Activation by E-mail	1-13
Chapter 2. Method of Solution	2-1
The Global Coordinate system	2-1
Mesh Generation	2-2
Preparing the Input	2-3
The Plate Element	2-4
Nodal Restraints and Slaved Degrees-of-Freedom	2-5
The Winkler's foundation	2-6
Piles	2-6
The Nonlinear Solution	2-7
Types of Loads	2-7
Load Cases and Combinations	2-9
The Solution	2-9
Element Nodal Moments	2-10
Element Design Moments	2-11
Required Reinforcement	2-12
Maximum reinforcement	2-13

Minimum reinforcement.....	2-14
Punching shear check	2-14
Program Results	2-16
Load Vector:.....	2-16
Nodal Displacements and Rotations:.....	2-16
Nodal Spring Displacements and Reactions:.....	2-17
Element Soil Displacements and Pressures:	2-17
Element Nodal Moments:	2-17
Nodal Displacement Envelopes:.....	2-17
Nodal Spring Displacement and Reaction Envelopes:	2-17
Element Soil Displacement and Pressure Envelopes:.....	2-17
Element Top Moment Envelopes:	2-18
Element Bottom Design Moment and Reinforcement:.....	2-18
Element Top Design Moment and Reinforcement:	2-18
References	2-18
Chapter 3. The pcaMats Interface.....	3-1
Control-Menu:	3-2
Title Bar:.....	3-2
Min/Max/Close Buttons:	3-2
Tool Bar:.....	3-3
Menu Bar:	3-3
Status Bar:	3-3
Tabs (on Main Window):	3-3
Graphics/Input Area (on Main Window):.....	3-3
Item Listing Area (on Main Window):.....	3-3
Information Area (on Main Window):	3-4
Using the Menus.....	3-4
Menu Conventions.....	3-4
Using a Dialog Box	3-5
Using the Tool Bar	3-6
Working with a List Box	3-9
To select a single item from a list box:	3-9
To select multiple sequential items in a list:.....	3-9
To select multiple non-sequential items in a list:	3-10
Working with a Drop-Down List.....	3-10
Working with a Text Box	3-11
Using a Command Button	3-11
Using a Radio Button	3-11
Using a Check Box.....	3-11
Zooming and Translating while Assigning.....	3-12

Using the mouse:.....	3-12
File Menu.....	3-12
New.....	3-12
Open.....	3-12
Save.....	3-12
Save As.....	3-12
Revert.....	3-13
Print Results.....	3-13
Print Screen.....	3-13
Exit.....	3-13
Define Menu.....	3-13
General Info.....	3-13
Grid.....	3-13
Library.....	3-14
Thickness.....	3-14
Concrete.....	3-14
Soil.....	3-14
Reinforcing Steel.....	3-14
Design Parameters.....	3-14
Columns.....	3-14
Nodal Springs.....	3-14
Slaved Nodes.....	3-14
Piles.....	3-14
Loads.....	3-15
Load Combinations.....	3-15
Assign Menu.....	3-15
Thickness.....	3-15
Concrete.....	3-15
Soil.....	3-15
Reinforcing Steel.....	3-15
Design Parameters.....	3-15
Columns.....	3-15
Nodal Springs.....	3-15
Slaved Nodes.....	3-16
Restraints.....	3-16
Piles.....	3-16
Surface Loads.....	3-16
Nodal Loads.....	3-16
Solve.....	3-16
Execute.....	3-16

View Results.....	3-16
View Contours.....	3-16
View Menu.....	3-16
3D.....	3-16
Status Bar.....	3-17
This Menu (Ctrl+F12).....	3-17
Reset.....	3-17
Zoom-in.....	3-17
Zoom-out.....	3-17
Rotate.....	3-17
Pan.....	3-17
Options Menu.....	3-17
Startup defaults.....	3-17
Autosave.....	3-17
Font & Color.....	3-18
Statistics.....	3-18
Vertical scale.....	3-18
Display preferences.....	3-18
Help Menu.....	3-18
Help Topics.....	3-18
About pcaMats.....	3-18
Chapter 4. Operating pcaMats.....	4-1
Creating a New Data File.....	4-1
Opening an Existing Data File.....	4-2
Saving the Data.....	4-2
To save your data with the same filename:.....	4-2
To save your data for the first time or to give an existing data file a new.....	4-3
Reverting to the Last Saved Data File.....	4-3
Printing Results.....	4-4
Printing the screen.....	4-6
Exiting the Program.....	4-7
Defining the General Info.....	4-7
Defining the Grid.....	4-8
To Enter Grid Lines Individually:.....	4-9
To Delete Grid Lines:.....	4-9
To Edit the Position of a Grid Line:.....	4-10
To Generate Grid Lines:.....	4-10
To Remove all the Grid Lines:.....	4-10
To Choose the Grid View Preferences:.....	4-10
To View the Grid Coordinates:.....	4-11

Managing Libraries	4-11
To Assign Items from a Library to the Current Project:	4-13
To Create and Save a Library:.....	4-13
Defining material Properties	4-14
To define the Element Thickness4-.....	4-15
To Define the Soil Properties:.....	4-15
To Define the Concrete Properties: 4-.....	4-16
To Define the Reinforcing Steel Properties:	4-17
To Define the Design Parameters:	4-17
To Define the Column Dimensions:.....	4-18
Defining the Restraints.....	4-19
To Define the Nodal Springs:	4-19
To Define the Slaved Nodes:	4-20
To Define the Piles:.....	4-20
Defining the Loads.....	4-22
To Define the Concentrated Load(s):.....	4-22
To Define the Surface Load(s):	4-23
Defining the Load Combinations	4-23
Assigning the material properties.....	4-25
To Assign the Element Thickness:.....	4-25
To Assign the Soil Properties:.....	4-26
To Assign the Concrete Properties:.....	4-27
To Assign the Reinforcing Steel Properties:	4-27
To Assign Design Parameters:	4-28
To Assign the Columns:.....	4-28
Assigning the Restraints.....	4-29
To Assign Nodal Restraints:	4-30
To Assign Nodal Springs:	4-30
To Assign Slaved Nodes:	4-31
To Assign Piles:	4-31
Applying the loads	4-32
To Apply Surface Loads:	4-33
To Apply Concentrated (Nodal) Loads:.....	4-33
Solving the model	4-34
Viewing the Results	4-36
Viewing the Contours	4-37
Accessing the 3D View.....	4-38
Using the Zoom Command:	4-38
Using the Pan Command:.....	4-39
Using the Reset Command:.....	4-40

Using the Rotate Command:.....	4-40
Defining the Options	4-40
To Define the Startup Defaults:.....	4-41
To Control the Autosave feature:	4-41
To Customize the Font and Color:.....	4-42
To View the Project Statistics:	4-42
Chapter 5. Examples.....	5-1
Helpful Hints	5-1
Example 1	5-2
Inputting Problem Databases.....	5-2
Assigning Properties.....	5-7
Solving.....	5-8
Viewing and Printing Results	5-9
Example 2.....	5-11
Inputting Problem Databases.....	5-14
Assigning Properties.....	5-23
Solving.....	5-26
Viewing and Printing Results	5-27
Appendix	A-1
Conversion Factors - English to SI.....	A-1
Conversion Factors - SI to English.....	A-1
Contact Information.....	A-2
Bug Report Form.....	A-3

Chapter 1

Introduction

Terms

The following terms are used throughout this manual. A brief explanation is given to help familiarize you with them.

Windows	refers to the Microsoft Windows environment version 3.1 or higher.
[]	indicates metric equivalent
Click on	means to position the cursor on top of a designated item or location and press and release the left-mouse button (unless instructed to use the right-mouse button).
Double-click on	means to position the cursor on top of a designated item or location and press and release the left-mouse button twice in quick succession.
Marquee select	means to depress the mouse button and continue to hold it down while moving the mouse. As you drag the mouse, a rectangle (known as a marquee) follows the cursor. Release the mouse button and the area inside the marquee is selected.

Conventions

Various styles of text and layout have been used in this manual to help differentiate between different kinds of information. The styles and layout are explained below...

<i>Italic</i>	indicates a glossary item, or emphasizes a given word or phrase.
Bold	All bold typeface makes reference to either a menu or a menu item command such as File or Save , or a tab such as Description or Grid
Mono-space	indicates something you should enter with the keyboard. For example type "c:*.txt".
KEY + KEY	indicates a key combination. The plus sign indicates that you should press and hold the first key while pressing the second key, then release both keys. For example, "ALT + F" indicates that you should press the "ALT" key and hold it while you press the "F" key. then release both keys.
SMALL CAPS	Indicates the name of an object such as a dialog box or a dialog box component. For example, the OPEN dialog box or the CANCEL or MODIFY buttons.

System requirements

To use pcaMats, a personal computer with one of the following operating systems is required...

- Microsoft Windows 98 or later
- Windows ME
- Windows XP
- Windows NT
- Windows 2000 Server.

Minimum Requirements

- 32 MB of RAM
- CD-ROM drive

- 50 MB free space on hard drive
- A mouse or other pointing device

Recommended Options

A printer supported by one of the operating systems listed above.

Program Capacity

- 255 X-grid lines
- 255 Y-grid lines
- 255 Thickness definitions
- 255 Concrete definitions
- 255 Soil definitions
- 255 Nodal spring definitions
- 255 Slaved nodes definitions
- 255 Pile definitions
- 255 Concentrated load definitions per load case
- 255 Surface load definitions per load case
- 255 Load combinations
- Approximately 10,000 nodes and 10,000 elements

With the minimum required RAM memory of 32MB, problems with 2,500 elements and 2601 nodes (7803 equations) were solved. Depending on the available amount of RAM memory and hard disk space, larger problems may be solved.

Installing pcaMats

1. If you have the installation disk please insert it into the CD drive and proceed to step 2. If you do not have the installation disk but downloaded the installation file from our website, please run the file and proceed to step 3.
2. If the installation does not start automatically after inserting the installation disk to the CD drive then please run the file install.exe from the installation disk and proceed to step 3. If the installation starts automatically then please follow the instructions on the screen. You may be asked which product you want to install if you received pcaMats together with other software from pcaStructurePoint.
3. The installation process starts by displaying the following window (Figure 1-1). Please read all the information. Then press the NEXT button. This will continue the installation process by installing license manager, an evaluation license, and the application software.

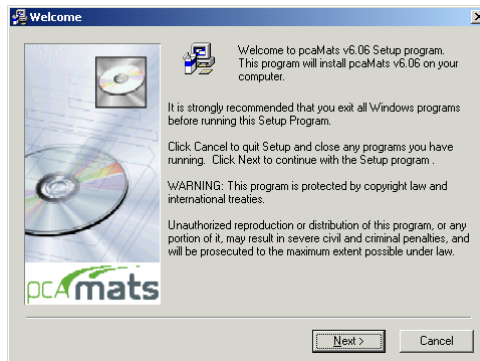

Figure 1-1. Beginning of the installation

4. The first step of the application installation process is to review the software license agreement as shown in Figure 1-2. Please read all the information carefully. Press the I AGREE button to confirm that you have read and agreed with it. This will continue the installation. If you do not agree with the license agreement press the I DO NOT AGREE button. This will stop the installation.

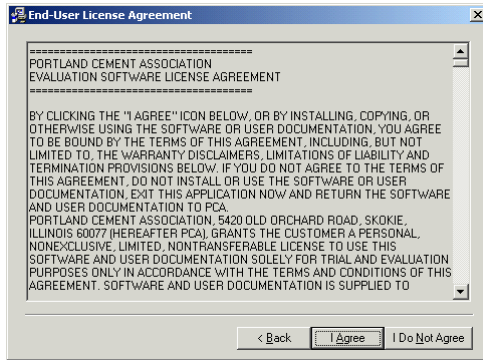

Figure 1-2. License agreement

5. If you continue the installation then please read the latest information of the software included in the readme file (Figure 1-3). Having read all the information press the NEXT button.

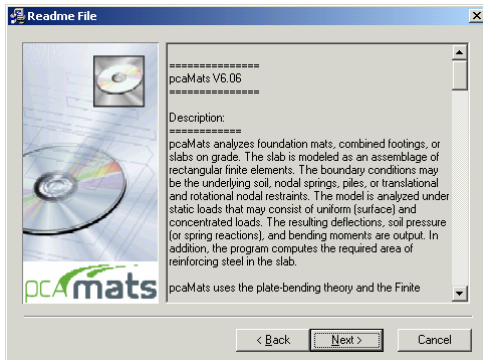

Figure 1-3. Readme file

6. In the next step please provide the user's name and company. Press next when you are ready to proceed.

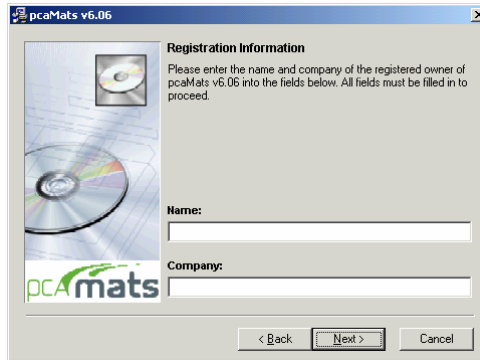

Figure 1-4. Registration information

7. The next setup is to decide the directory where pcaMats is to be installed as shown in Figure 1-5. The default one is C:\Program Files\PCA\pcaMats. You may press the BROWSE button to locate the directory. If the directory does not exist, the setup program will create it. Press the NEXT button to go to the next step.

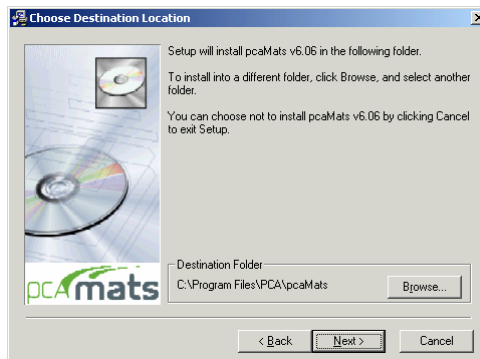

Figure 1-5. Choose Destination Location

8. The next step is to enter the group name as shown in Figure 1-6. Windows will use this name in the Start/Programs menu. Press the NEXT button to go to the next step.

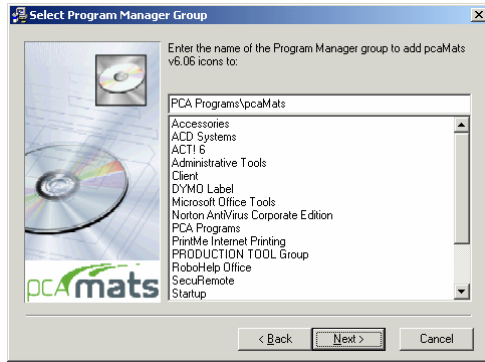

Figure 1-6. Select Program Manager Group

9. After all the previous steps are completed, press the NEXT button as shown in Figure 1-7 to start the installation.

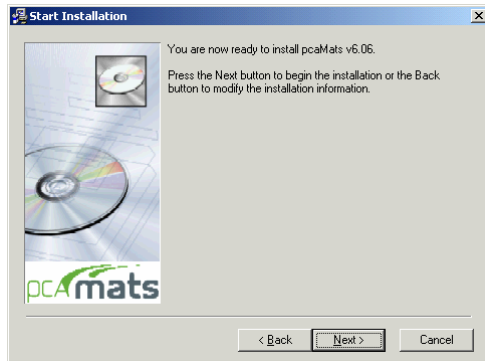

Figure 1-7. Start Installation

10. During the installation a window as in Fig. 1-8 shows the progress as files are copied to your hard drive.

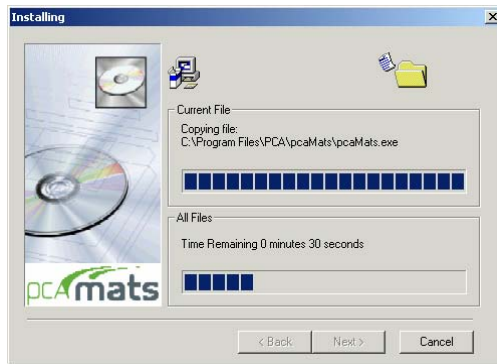

Figure 1-8. Installation progress

11. After the installation is completed, a dialog box similar to Figure 1-9 is shown. Press the FINISH button to finish the installation.

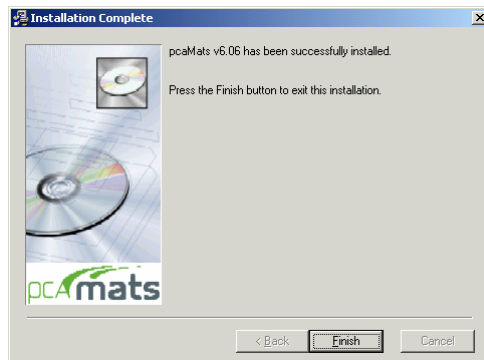

Figure 1-9. Installation Complete

Purchasing and Licensing Process

Licensing Model

By default, each pcaStructurePoint software application comes in an Evaluation mode. This means that initially our products can be used for a limited time of 15 days. If the user decides to purchase the software license, and completes the purchase, pcaStructurePoint will provide a License Code. By entering this code, user will activate the software license. Once the software license is activated the application will no longer have restrictions limiting the time of operation.

Evaluation Mode

This is the default mode of the license. In this licensing scheme, users are granted limited rights to use our full-featured software. The only visible difference between the evaluation version and the licensed version is an additional start-up dialog box as shown in Figure 1-8. It gives a choice of buying the software, entering the activation code or running the application in the evaluation mode by pressing the EVALUATE button. Evaluation mode is available for a limited time only. By default, pcaStructurePoint software applications come with 15 days. That means, from the day of installation, a user can evaluate the software for the next 15 days. After this time, user will either obtain a License, or uninstall the application.

Note: Any tampering with system clock or evaluation license file will render the software useless.

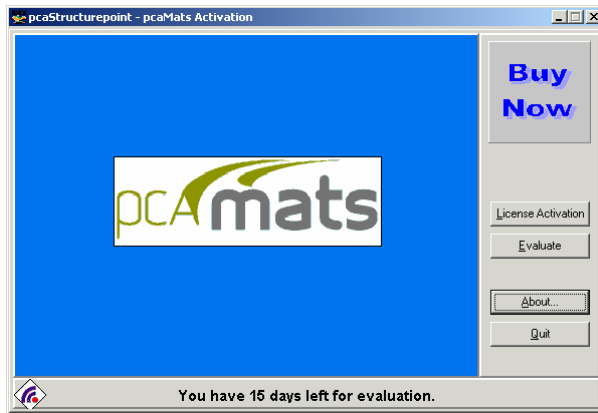

Figure 1-8. Start-up Dialog Box

How to Purchase

You may purchase the license on-line at www.pcaStructurePoint.com or by calling our Sales Department at 847-972-9042. To buy on-line you may press BUY NOW button, which will run your default web browser and open the product web page where you will be able to complete the transaction.

Licensing Activation

After the purchase is completed, pcaStructurePoint will generate a unique Activation Code based on the product ID and the locking code, which is derived from the unique hardware-id of the user's computer. Each License is associated

with the particular PC in which user has installed the pcaStructurePoint software. This implies that the activation-code will not work on any other PC. You can transfer the license to another PC by contacting pcaStructurePoint for the transfer procedures.

To activate the license press the LICENSE ACTIVATION button in the start-up dialog box. This will bring a window as in Figure 1-9, which shows three license activation methods.

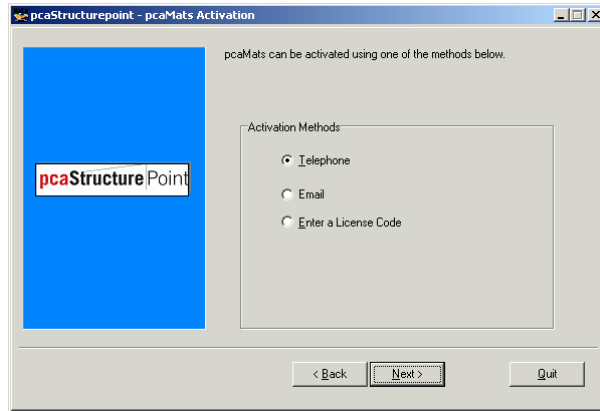

Figure 1-9. License activation methods

If you have already received the license code you may choose ENTER LICENSE CODE and then press the NEXT button. A window (Figure 1-9) will pop up where you will be able to type in the license code. However, in order to avoid mistyping we advise to use copy and paste feature instead of typing the code.

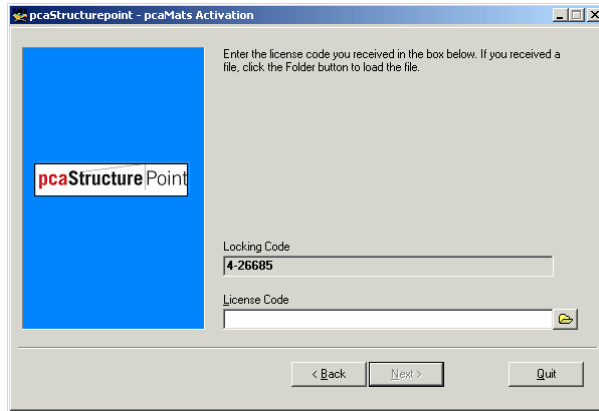



Figure 1-9. Enter license code

The license code can also be extracted from a file. To do that press the BROWSE button  and open the file in which the license code is stored using the open window (Figure 1-10).

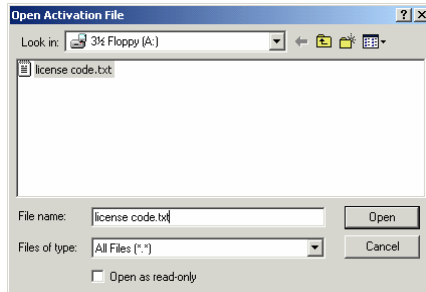

Figure 1-10. Open activation file

If the entered code is correct the license will be activated and window as in Figure 1-11 will show. When you press the FINISH button the license activation will be completed.

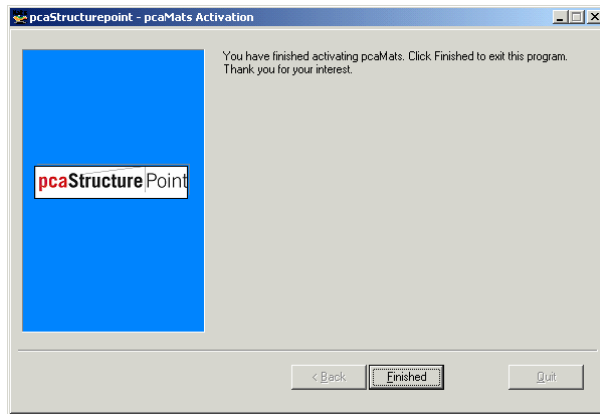

Figure 1-11. Activation completion

If you do not have the license code you may chose either TELEPHONE or E-MAIL method, whichever is more convenient for you. Please note that for E-MAIL method you need to have the Internet connection and a default mailer configured in your system.

Activation by Phone

If the telephone method was chosen to activate the license the following screen appears (Figure 1-12). It shows the product ID and the Locking Code.

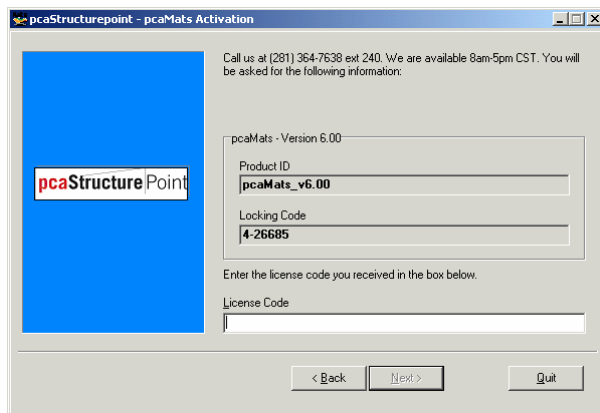

Figure 1-12. Activation by phone

This information is needed when you make a phone call at 847-966-4357 (HELP) to obtain the license. You will be asked to provide information about yourself in order to verify that you have purchased the license.

Activation by E-mail

If the e-mail method was chosen to activate the license a screen (Figure 1-13) will show prompting you to provide information about yourself. When you type in all the information press the SEND E-MAIL button and it will be automatically e-mailed to us together with the product ID and the Locking Code. After the information is verified the license code will be generated and e-mailed back to you.

The screenshot shows a software activation dialog box titled "pcaStructurepoint - pcaMats Activation". On the left is a blue panel with the "pcaStructurePoint" logo. The main area contains a form with the following fields: "Company", "*Name", "*Street Address", "*City", "State/Province", "Zip/Postal Code", "*Country" (a dropdown menu), "E-mail Address", "*Phone Number", and "Fax Number". Asterisks indicate required fields. At the bottom are three buttons: "< Back", "Send E-mail", and "Quit".

Figure 1-13. Activation by e-mail

After you receive it you may enter it by pressing the LICENSE ACTIVATION button in the start up dialog box (Figure 1-8) and choosing ENTER LICENSE CODE option. . If the entered code is correct, the license will be activated and window as in Figure 1-11 will show. When you press the FINISH button the license activation will be completed.

Chapter 2

Method of Solution

pcaMats uses the Finite Element Method for the structural modeling and analysis of reinforced concrete slab systems or mat foundations subject to static loading conditions.

The slab is idealized as a mesh of rectangular elements interconnected only at the corner nodes. The same mesh applies to the underlying soil with the soil stiffness concentrated at the nodes. Slabs of irregular geometry should be idealized to conform to a geometry with rectangular boundaries. Even though slab and soil properties can vary from one element to another, they are assumed uniform within each element.

Three degrees of freedom exist at each node: vertical deflection and two rotations about the two rectangular axes. An external load can exist in the direction of each of the above deformations, i.e., a vertical force and two moments about the Cartesian axes. The internal stress resultants are related to the degrees of freedom of an element.

The Global Coordinate system

The mid-surface of the slab lies in the XY plane of the right-handed XYZ rectangular coordinate system shown in Figure 2-1. The slab thickness is measured in the direction of the Z-axis. Looking at the display monitor, the origin of the coordinate system is located in the bottom left corner of the screen. The positive X-axis points to the right, the positive Y-axis points upward towards the top of the monitor, and the positive Z-axis points out of the screen. Thus, the XY plane is defined as being the plane of the display monitor.

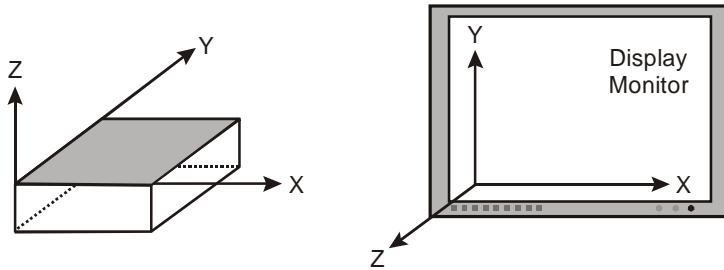

Figure 2-1. The Global Coordinate System

Mesh Generation

The nodal coordinates of the finite element mesh are internally computed by the program based on the reference rectangular grid system shown in Figure 2-2.

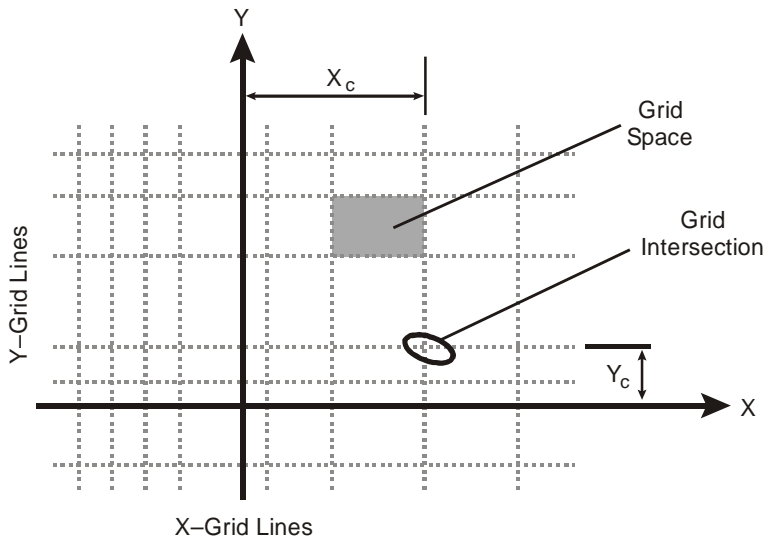

Figure 2-2. The Reference Grid System

A group of *grid lines*, orthogonal to the X and Y-axes, are defined by inputting their coordinates. The intersection of two orthogonal grid lines forms a *grid intersection*. The space formed by the intersection of two consecutive X-grid lines and two consecutive Y-grid lines is a *grid space*. The assembling of plate finite

elements to the slab system is done by assigning element thicknesses to the grid spaces.

Preparing the Input

The first step in preparing the input is to draw a scaled plan view of the slab. The plan should include the boundaries slab, variations in the slab thickness and material properties, openings within the slab, and any variations in the soil sub-grade modulus. All superimposed loads applied on the slab should also be shown.

The next step is to superimpose a rectangular grid system over the plan of the slab. The following factors control the grid layout:

1. Grid lines must exist along slab boundaries and openings. Slab boundaries not parallel to the X- or Y-axis may be defined by steps that approximate the sloped boundary.
2. Grid lines must exist along the boundaries of slab thickness changes, slab material property changes, and soil property changes.
3. Grid lines must exist along boundaries of surface loads.
4. Grid lines must intersect at the locations of point loads and point supports.

The above guidelines basically form the major grid lines, which produce the minimum number of finite elements for the particular mat geometry. The mesh can be refined by supplementing the model with minor grid lines between the major grid lines. Minor grid lines need to be added to achieve a uniform, well-graded mesh that produces results that will effectively capture the variations of the displacements and element forces. The location of the minor grid lines also depends on the level of accuracy that is desired from the analysis.

While the use of finer meshes will generally produce more accurate results, it will also require more solution time, computer memory, and disk space. Elements with length or width about 1.5 times the thickness and with aspect ratios (length/width) near unity are generally expected to produce accurate results for regions having gradual changes of curvature. For slab regions where heavy concentrated forces are applied and where drastic changes in geometry exist, the use of finer element meshes may be required. Thus, in order to obtain a practical as well as an accurate analytical solution, engineering judgment must be used.

The member nodal incidences are internally computed by the program. All nodes and members are numbered from left to right (in the positive X-direction) and from bottom to top (in the positive Y-direction), as shown in Figure 2-3. When the

reference grid system and/or assembling of elements is modified, the program internally modifies all nodes and elements.

Since the internal sequence of degrees-of-freedom follows the nodal numbering, and since pcaMats uses a modified Crout equation solver, the side of the slab with less nodes (i.e. less degrees-of-freedom) should be considered in the X-direction in order to save solution time, memory and disk space.

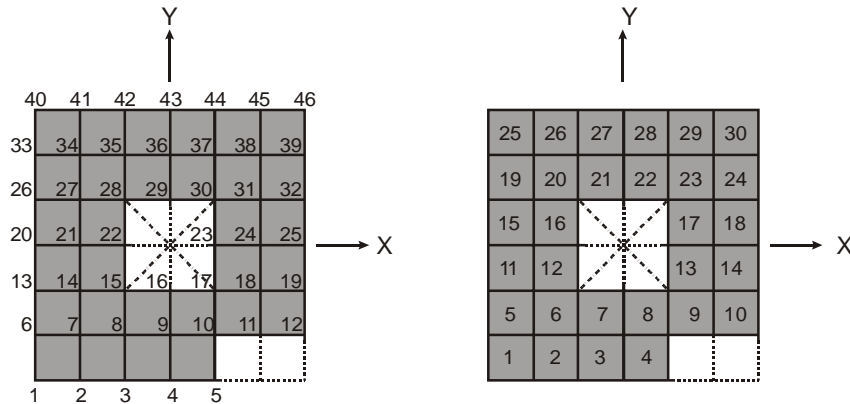

Figure 2-3. Node and Element Numbering

The Plate Element

The rectangular plate finite element used in the program has four nodes at the corners and three degrees of freedom (D_z , R_x and R_y) per node, as shown in Figure 2-4. This element considers the thin plate theory, which makes use of the following Kirchhoff hypotheses:

1. The deflection of the mid-surface is small compared to the thickness of the plate.
2. The mid-plane remains unstrained subsequent to bending.
3. Plan sections initially normal to the mid-surface remain plane and normal to that surface after bending.
4. The stress component normal to the mid-plane is small compared to other stress components and is neglected.

The element material is homogeneous, elastic, isotropic, and obeys Hooke's law.

Note that when deflections are not small, the bending of plates is accompanied by strain in the mid-plane. Further, for thick slabs, shear deformations (which are not considered by the program) may be significant, and a finite plate element based on the more general Mindlin's Theory may be required. The element formulation considers constant thickness and material properties. Consequently, cracking effects or changes in the slab elevation are not taken into account.

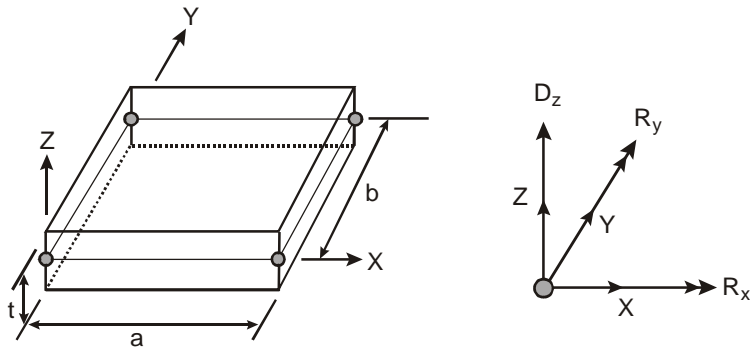

Figure 2-4. The Plate Finite Element

Nodal Restraints and Slaved Degrees-of-Freedom

All nodal degrees-of-freedom (DOF) are assumed to be initially released (i.e., free to move). Mathematically speaking, each DOF implies an equilibrium equation; however, nodal DOFs may be fully restrained against displacement and/or rotation. Furthermore, they may be slaved to share the same displacement or rotation at specific nodes.

Slaving of degrees-of-freedom produces a stiffer slab system and reduces the number of equations to be solved. It should be noted that slaved degrees-of-freedom (SLDOF) are assigned by grouping of nodes. A group of nodes can be designated to share the same D_z , R_x or R_y . If a group of nodes should share all three degrees-of-freedom, three different SLDOF groups (one for each DOF) must be defined. It should also be noted that a node can belong to more than one SLDOF group as long as these groups are slaved for different degrees-of-freedom. The external load corresponding to a SLDOF group corresponds to the sum of loads applied to all slaved nodes in the groups.

The Winkler's foundation

The soil supporting the slab is modeled as a group of linear uncoupled springs (Winkler type) concentrated at the nodes. The soil element is tensionless, weightless, and has one degree of freedom, which is the displacement in the Z direction (D_z). The contribution of each element node to the soil spring stiffness is simply the nodal tributary area (1/4 the element area) times the soil subgrade modulus K_s , under the element.

The contact pressure, P_z , under each element node is proportional to the nodal deflection, D_z .

$$P_z = K_s D_z . \quad \text{Eq. 2-1}$$

Usually, several factors are considered in the determination of the subgrade modulus: the size and shape of the footing, soil type below the footing and at greater depths, type and duration of loading, footing stiffness, and superstructure stiffness. The program does not perform any correction on the input subgrade modulus to account for these or any other factors.

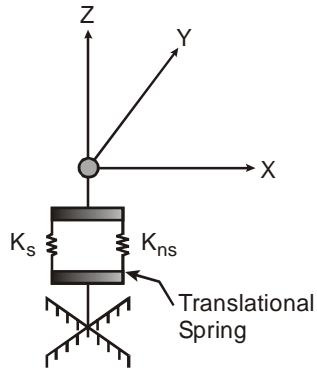

Figure 2-4. The Soil Element

Additional nodal springs may be assembled in parallel to the Winkler's springs, as shown in Figure 2-5. Accordingly, their linear stiffness, K_{ns} , is added to the equivalent nodal spring constant.

The spring reaction at a particular node is proportional to the nodal deflection, D_z .

$$F_z = K_{ns} D_z . \quad \text{Eq. 2-2}$$

Piles

Piles are modeled as springs connected to the nodes of the finite element model. However, in this case, punching shear check is also performed. It is not for the additional springs described in the previous chapter.

The spring constant K_p for a pile is calculated from the formula

$$K_p = \frac{Q_u}{S} , \quad \text{Eq. 2-3}$$

where Q_u denotes the load applied to the pile and S is the corresponding settlement of the pile. Assuming soil allowable pressure P_{all} acting on the pile base, Q_u equals $P_{all} \cdot A_p$, where A_p is pile cross sectional area. Neglecting long-term effects, the settlement of pile is estimated from the empirical formula for a single pile in cohesionless soil [8]:

$$S = \frac{D}{100} + \frac{Q_u L}{A_p E_p}, \quad \text{Eq. 2-4}$$

where D is pile diameter, L is pile length, and E_p is modulus of elasticity of pile material. For noncircular piles an effective diameter is calculated from the formula

$$D = \sqrt{\frac{4A_p}{\pi}}. \quad \text{Eq. 2-5}$$

The Nonlinear Solution

The supporting soil is assumed to be tensionless. When tensile contact pressure (nodal uplift) occurs, an iterative procedure is used to eliminate the corresponding nodal spring stiffness contribution to the global stiffness of the entire slab/soil structural system and to re-solve the equilibrium equations.

A maximum number of iterations, as well as a maximum displacement limit, are the controlling parameters for the solution of the nonlinear problem. This iterative procedure is repeated for each load combination. When the limits are exceeded for a particular load combination, the program still attempts to solve for the remaining load combinations.

Types of Loads

External loads are applied as concentrated nodal loads and/or element surface loads according to the sign convention shown in Figure 2-6.

A concentrated nodal load consists of a vertical load, P_z , and two concentrated moments about the X and Y axes, M_x and M_y . It should be noted that a positive vertical load is applied upward (in the positive Z -direction).

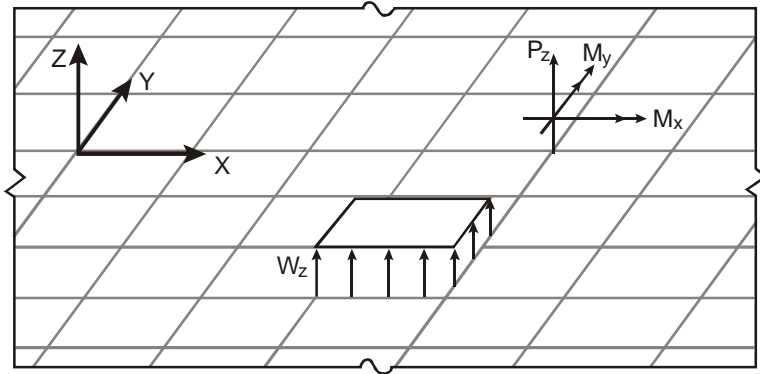

Figure 2-6. The Applied Loads

The uniform element surface load, w_z , applied over an element is internally discretized by the program into equivalent nodal loads as shown in Eq. 2-6.

$$\begin{Bmatrix} P_{iz} \\ M_{ix} \\ M_{iy} \\ P_{jz} \\ M_{jx} \\ M_{jy} \\ P_{kz} \\ M_{kx} \\ M_{ky} \\ P_{lz} \\ M_{lx} \\ M_{ly} \end{Bmatrix} = w_z \cdot \begin{Bmatrix} 1/4 \\ -b/24 \\ a/24 \\ 1/4 \\ b/24 \\ a/24 \\ 1/4 \\ -b/24 \\ -a/24 \\ 1/4 \\ b/24 \\ -a/24 \end{Bmatrix} \cdot a \cdot b \quad \text{Eq. 2-6}$$

where a and b are the element dimensions.

The self-weight of the slab is computed internally based on the concrete unit weight and the thickness of each element. The self-weight is treated like a surface load and may optionally be considered in the analysis under the dead load case.

Load Cases and Combinations

All applied loads are categorized into six load cases: *A* through *F*. Loads are applied to the slab under a load case. The slab is analyzed and designed under load combinations. A load combination is the algebraic sum of each of the load cases multiplied by a load factor.

Load combinations are categorized into Service level and Ultimate level. For each service level combination, the nodal deflections, element pressures, and nodal spring reactions are output. For an ultimate level combination, the element bending moments are output.

The Solution

The solution process is summarized in the following steps:

1. Compute the plate element stiffness matrix¹
2. Compute the soil element stiffness matrix.
3. Assemble the global stiffness matrix.
4. Combine the applied loads based on the defined load combinations and form the load vector.
5. Compute the displacement vector, *U*, by solving the equilibrium equation:

$$KU = F, \quad \text{Eq. 2-7}$$

where *K* is the structural stiffness matrix and *F* is the load vector.

6. If uplift is detected at any node (upward displacement), the soil contribution at that node is eliminated and the procedure (from step 2 above) is repeated. This is checked only if soil is present.
7. Compute the spring reactions and soil pressures (service combinations only).
8. Compute the moments at the element nodes (ultimate combinations only).
9. Repeat steps 4 through 8 for each combination.
10. For all service level combinations, envelopes are computed for displacements, pressures, and spring reactions.

¹ Reference 5.

11. For all ultimate level combinations, the element bending moment envelopes are computed along with the corresponding required area of reinforcing steel.

Element Nodal Moments

The orthogonal moments, M_{xx} and M_{yy} , and the torsional moment, M_{xy} , are computed at the corner nodes of each element. Figure 2-7 shows the element moment sign convention used by the program. Note that M_{xx} is the moment *along* the X-axis and M_{yy} is the moment *along* the Y-axis. Both moments are positive when they produce tension at the top.

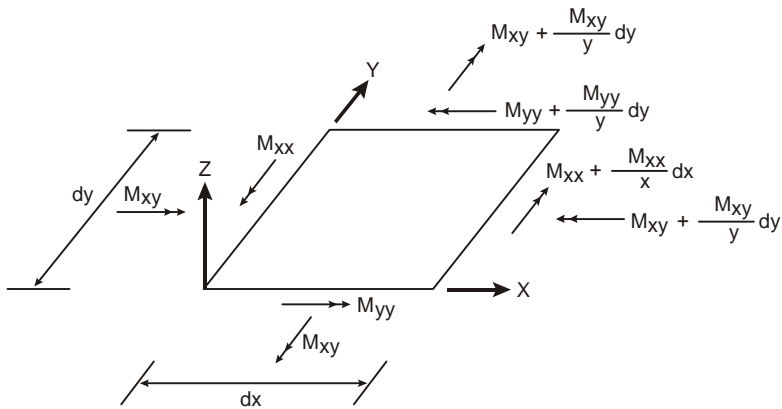

Figure 2-7. Element Nodal Moments

The principal moments, M_{r1} and M_{r2} , and the principal angle (see Figure 2-8), are computed from the general moment transformation equations:

$$M_{r1} = M_{xx} \cos^2 \theta + M_{yy} \sin^2 \theta + M_{xy} \sin(2\theta), \quad \text{Eq. 2-8}$$

$$M_{r2} = M_{xx} \sin^2 \theta + M_{yy} \cos^2 \theta - M_{xy} \sin(2\theta). \quad \text{Eq. 2-9}$$

Note that since M_{r1} and M_{r2} are principal moments, the torsional moment associated with the r_1 - r_2 axes (M_{r12}) is zero:

$$M_{r12} = \frac{M_{yy} - M_{xx}}{2} \sin(2\theta) + M_{xy} \cos(2\theta) = 0, \quad \text{Eq. 2-10}$$

and the angle θ is

$$\theta = \frac{1}{2} \tan^{-1} \left(\frac{2M_{xy}}{M_{xx} - M_{yy}} \right). \quad \text{Eq. 2-11}$$

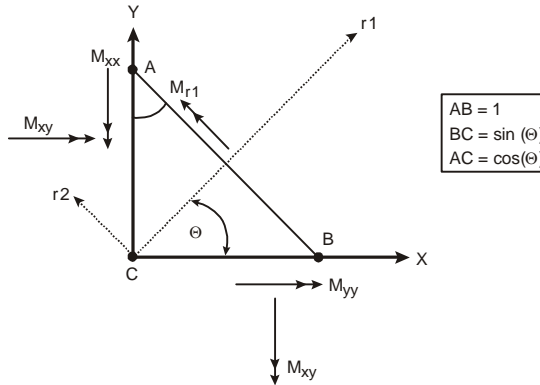

Figure 2-7. Element Principal Moment

Element Design Moments

In practice, flexural reinforcement is generally provided in the orthogonal directions of the slab system (X-Y) and not in the principal directions (r_1 - r_2). Therefore, the Principle of Minimum Resistance² is used by the program to obtain values for the design moments, which include the effects of the torsional moment.

The equivalent design orthogonal moments M_{ux} and M_{uy} are computed as follows:

- For top reinforcement where positive moments produce tension:

$$M_{ux} = M_{xx} + |M_{xy}|, \quad \text{Eq. 2-12}$$

$$M_{uy} = M_{yy} + |M_{xy}|. \quad \text{Eq. 2-13}$$

However, if either M_{ux} or M_{uy} is found to be negative, the negative value of the moment is changed to zero and the other moment is given as follows:

$$\text{if } M_{ux} < 0, \text{ then } M_{ux} = 0 \text{ and } M_{uy} = M_{yy} + \frac{M_{xy}^2}{M_{xx}}, \quad \text{Eq. 2-14}$$

² References 1, 2, 3, and 4.

$$\text{if } M_{uy} < 0, \text{ then } M_{uy} = 0 \text{ and } M_{uy} = M_{xx} + \left| \frac{M_{xy}^2}{M_{yy}} \right|. \quad \text{Eq. 2-15}$$

- For bottom reinforcement where negative moments produce tension:

$$M_{ux} = M_{xx} - |M_{xy}|, \quad \text{Eq. 2-16}$$

$$M_{uy} = M_{yy} - |M_{xy}|. \quad \text{Eq. 2-17}$$

However, if either M_{ux} or M_{uy} is found to be positive, the positive value of the moment is changed to zero and the other moment is given as follows:

$$\text{if } M_{ux} > 0, \text{ then } M_{ux} = 0 \text{ and } M_{uy} = M_{yy} - \left| \frac{M_{xy}^2}{M_{xx}} \right|, \quad \text{Eq. 2-18}$$

$$\text{if } M_{uy} > 0, \text{ then } M_{uy} = 0 \text{ and } M_{ux} = M_{xx} - \left| \frac{M_{xy}^2}{M_{yy}} \right|. \quad \text{Eq. 2-19}$$

In the above equations, M_{xx} , M_{yy} and M_{xy} correspond to the maximum principal moment obtained from all nodes and all ultimate load combinations.

Required Reinforcement

The required area of reinforcing steel is computed based on a rectangular section with no compression reinforcement and one layer of tension reinforcement. The assumptions and limits used conform to the design specifications based on the accepted Strength Design or Limit States theories.

The maximum usable strain at the extreme concrete compression fiber is assumed to be 0.003 (0.0035 for CSA). To compute the stress in the steel layer, the elastic-perfectly plastic stress-strain distribution is used. A rectangular concrete stress block is used, for which the block depth is:

$$a = \beta_1 c, \quad \text{Eq. 2-20}$$

where c is the distance from the extreme compression fiber to the neutral axis.

For the ACI Code:

$$0.65 \leq \beta_1 = 1.05 - 0.05f'_c \leq 0.85 . \quad \text{Eq. 2-21}$$

For the CSA Standard:

$$0.67 \leq \beta_1 = 1.05 - 0.025f'_c . \quad \text{Eq. 2-22}$$

The required area of reinforcing steel is:

$$A_s = \rho b d , \quad \text{Eq. 2-23}$$

$$\rho = g(1 - \sqrt{1 - m}) , \quad \text{Eq. 2-24}$$

$$m = \frac{2M_u}{\alpha_1 f'_c b d^2 \phi_c \phi_f} , \quad \text{Eq. 2-25}$$

$$g = \alpha_1 \frac{\phi_c f'_c}{\phi_s f_y} . \quad \text{Eq. 2-26}$$

Factor α_1 is the ratio of the average stress in the rectangular compression block to the specified concrete strength. It equals 0.85 for ACI Code and $0.85 - 0.0015f'_c$ but not less than 0.67 for the CSA Standard.

Maximum reinforcement

For the ACI Code, the maximum reinforcement ratio is derived from the condition³ that the net tensile strain at nominal strength is not less than 0.004.

For the CSA Standard, the area of tension reinforcement is such that the neutral axis-to-depth ratio is⁴:

$$\frac{c}{d} < \frac{700}{700 + f_y} \quad \text{Eq. 2-27}$$

When the required area of steel exceeds the maximum allowed by the code, the program outputs the moment capacity, M_{\max} , based on the maximum allowed steel area.

³ ACI 318-02, 10.3.5

⁴ CSA A23.3-94, 10.5.2

Minimum reinforcement

The minimum reinforcement is computed as the minimum reinforcement ratio defined by the user times the gross area.

Punching shear check

The punching shear in pcAMats is checked for columns and piles as per:

$$v_u \leq \phi v_n, \quad \text{Eq. 2-28}$$

where

v = factored shear stress,

v_n = nominal shear resistance of slab,

ϕ = shear resistance factor equal to 0.75 for ACI Code and 0.60 for CSA Standard.

The nominal shear resistance, v_n , is a sum of nominal shear resistance provided by shear reinforcement, v_s , and nominal shear resistance, v_c , provided by concrete. In pcAMats v_s is assumed to be zero and v_c is taken as the smallest of v_{c1} , v_{c2} , and v_{c3} . For the ACI Code

$$v_{c1} = \left(2 + \frac{4}{\beta_c} \right) \lambda \sqrt{f'_c}, \quad \text{Eq. 2-29}$$

$$v_{c2} = \left(2 + \frac{\alpha_s d}{b_0} \right) \lambda \sqrt{f'_c}, \quad \text{Eq. 2-30}$$

$$v_{c3} = 4 \lambda \sqrt{f'_c}, \quad \text{Eq. 2-31}$$

where:

β_c = the ratio of long side to short side of the column (or the pile),

α_s = 40 for interior columns, 30 for edge columns, 20 for corner columns,

b_0 = perimeter of the critical section,

d = average effective depth of the critical section segments,

$\sqrt{f'_c}$ = square root of compressive strength of concrete.

For the CSA Standard:

$$v_{c1} = \left(0.2 + \frac{0.4}{\beta_c} \right) \lambda \sqrt{f'_c}, \quad \text{Eq. 2-32}$$

$$v_{c2} = \left(0.2 + \frac{\alpha_s d}{b_0} \right) \lambda \sqrt{f'_c}, \quad \text{Eq. 2-33}$$

$$v_{c3} = 0.4 \lambda \sqrt{f'_c}, \quad \text{Eq. 2-34}$$

with α_s equal 4 for interior columns, 3 for edge columns, and 2 for corner columns. Factor λ is used to account for lightweight concrete and is equal to 1.0 for normal concrete, 0.85 for sand-lightweight concrete and 0.75 for lightweight concrete. These values apply to both ACI Code and CSA Standard.

The projection of the critical section to the middle surface of the slab is a polygon located so its perimeter b_0 is a minimum and the distance between its segments and the column is not less than a half of slab effective depth. For circular column and piles, the critical section is approximated by a polygon with ten segments per quarter. The depth of each segment can be different depending on the depth of the slab at the location of the segment. In the case of edge or corner columns and piles, segments of the critical section that lie outside of the slab are disregarded.

For such defined section the area A_c , the coordinates $\{x_c, y_c\}$ of the centroid, and J_{xx} , J_{yy} , J_{xy} properties are calculated. Force (P_{uz}) and moments (M_{ux} and M_{uy}) applied at the center of the column (pile) are transformed to the centroid of the critical section. The unbalanced moments to be transferred by eccentricity of shear are:

$$M_{vx} = \gamma_{vx} (M_{ux} + P_{uz} (y_f - y_c)), \quad \text{Eq. 2-35}$$

$$M_{vy} = \gamma_{vy} (M_{uy} - P_{uz} (x_f - x_c)), \quad \text{Eq. 2-36}$$

where x_f , y_f are the coordinates of the column (pile) center. If B_x and B_y denote the dimensions of the critical section then the fractions of the unbalanced moments transferred by eccentricity of shear can be calculated as

$$\gamma_{vx} = 1 - \frac{1}{1 + \frac{2}{3} \sqrt{\frac{B_x}{B_y}}}, \quad \text{Eq. 2-37}$$

$$\gamma_{vy} = 1 - \frac{1}{1 + \frac{2}{3} \sqrt{\frac{B_y}{B_x}}}, \quad \text{Eq. 2-38}$$

At each vertex of the critical section, the factored shear stress v_u is calculated from the formula:

$$v_u(x, y) = \frac{P_{uz}}{A_c} + \frac{M_{vx}J_{yy} + M_{vy}J_{xy}}{J_{xx}J_{yy} - J_{xy}^2} y - \frac{M_{vy}J_{xx} + M_{vx}J_{xy}}{J_{xx}J_{yy} - J_{xy}^2} x, \quad \text{Eq. 2-39}$$

where x, y are the vertex coordinates relative to the centroid of the critical section. Vertex that governs the punching shear check is the one that has the maximum $|v_u|/(\phi v_c)$ ratio.

Program Results

The program output is organized into tables that may be optionally viewed, printed, or sent to a file. Furthermore, the tables may be fully or partially output for all or for only selected nodes, members and combinations.

The program distinguishes between individual (service or ultimate) combination results and envelope results (which include the maximum values from all load combinations). While envelope results are always saved, individual combination results are saved only if so selected in the LOAD COMBINATION dialog box.

Load Vector:

This table is output for individual ultimate load combinations. It lists the nodal load vector that is actually used by the program for each load combination. The axial force, F_z , moment about X , M_x , and moment about Y , M_y , at each node includes the factored dead, live and lateral forces at the node, including the discretized effects of uniform surface loads. Positive forces are applied in the direction of the positive Z -axis (upward) and positive moments are determined using the right-hand rule.

Nodal Displacements and Rotations:

This table is output for individual service and individual ultimate load combinations. It lists the displacement vector for each load combination. The table lists the displacement, D_z , and the two rotations about the X and Y -axis, R_x and R_y ,

respectively. Positive displacement is in the positive Z-direction, and the right-hand rule is used to determine the direction of the rotations.

Nodal Spring Displacements and Reactions:

This table is output for individual service load combinations. For the nodes with specified nodal springs, the displacement and reaction are listed. Since the soil is assumed tensionless, the pressure is set to zero for positive (upward) displacements.

Element Soil Displacements and Pressures:

This table is output for individual service load combinations. For the elements with specified soil, the displacement and pressure at all four nodes are listed. Since the soil is assumed tensionless, the pressure is set to zero for positive (upward) displacements.

Element Nodal Moments:

This table is output for individual ultimate load combinations. It lists, at each of the element four nodes (i, j, k and l), the orthogonal moments (M_{xx} and M_{yy}), the torsional moment (M_{xy}) and the equivalent principal moments (M_{r1} and M_{r2}), along with the principal angle. Note that M_{xx} and M_{yy} are positive when they produce tension at the top and are referred to as moments along the X and Y-axes, respectively. For more information about these moments and the sign convention, see “Element Nodal Moments” earlier in this chapter.

Nodal Displacement Envelopes:

This table lists the maximum vertical displacement, D_z , from all service load combinations, along with the governing combination. Again, positive displacements are upward in the positive Z-direction.

Nodal Spring Displacement and Reaction Envelopes:

For the nodes with specified nodal springs, this table lists the maximum displacements and reactions resulting from all service load combinations. The governing load combination is listed.

Element Soil Displacement and Pressure Envelopes:

For the elements with specified soil, this table lists the maximum displacements and pressures resulting from all service load combinations and all four element

nodes. The governing load combination and the governing element node are also listed.

Element Top Moment Envelopes:

For each element, the maximum nodal principal moment (M_{r1}) producing tension at the top resulting from all ultimate load combinations and all for element nodes is listed. The governing load combination and the governing element node are also listed, along with the corresponding nodal moments (M_{xx} , M_{yy} and M_{xy}) and the directional angle.

Element Bottom Design Moment and Reinforcement:

For each element, the maximum nodal principal moment (M_{r1}) producing tension at the bottom resulting from all ultimate load combinations and all four element nodes is listed. The governing load combination and the governing element node are also listed along with the corresponding nodal moments (M_{xx} , M_{yy} and M_{xy}) and the directional angle.

Element Top Design Moment and Reinforcement:

For each element, the maximum nodal principal moment (M_{r1}) producing tension at the top resulting from all ultimate load combinations and all four element nodes is listed. The governing load combination and the governing element node are also listed along with the corresponding directional angle and the required area of skewed reinforcement. The equivalent design orthogonal moment (M_{ux} and M_{uy}) with the required area of reinforcing steel is also listed (see “Element Design Moments” earlier in this chapter). If the required area of reinforcing steel exceeds the maximum allowed by the code, the ratio of the ultimate moment to the maximum moment capacity, (in percent), is reported instead.

References

- 1) Wood, R.H., “The Reinforcement of Slabs in Accordance with a Predetermined Field of Moments,” Concrete, February 1968.
- 2) Discussion to Article “The Reinforcement of Slabs in Accordance with Predetermined Field Moment,” Concrete, April 1968.
- 3) Gupta, A.K., and Sen Siddhartha, “Design of Flexural Reinforcement in Concrete Slabs,” Journal of the Structural Division, ASCE, Vol. 103, No. St4, April 1972.

- 4) Park, R. and Gamble, W.L., Reinforced Concrete Slabs, John Wiley & Sons, 1980. (Chapter 5, Section 5-4) pp. 181-204.
- 5) Zienkiewicz, O.C. and Taylor, R.L., The Finite Element Method, McGraw-Hill Book Company, Fourth Edition, 1988.
- 6) Bowles, Joseph F., Foundation Analysis and Design, McGraw-Hill Book Company, Fourth Edition, 1988
- 7) ACI 336.2R-88, “Suggested Analysis and Design Procedures for Combined Footings and Mats.”
- 8) Prakash, S., and Sharma, H.D., Pile Foundations in Engineering Practice, John Wiley & Sons, 1990, pp. 251.

Chapter 3

The *pcaMats* Interface

The *pcaMats* interface is made up of the elements as illustrated above. The content of the interface's *Main Window* changes depending on what you select from any menu displayed on the *Menu Bar* or from any button displayed in the *Tool Bar*. In the illustration above, the *Main Window* is shown contained within a black frame.

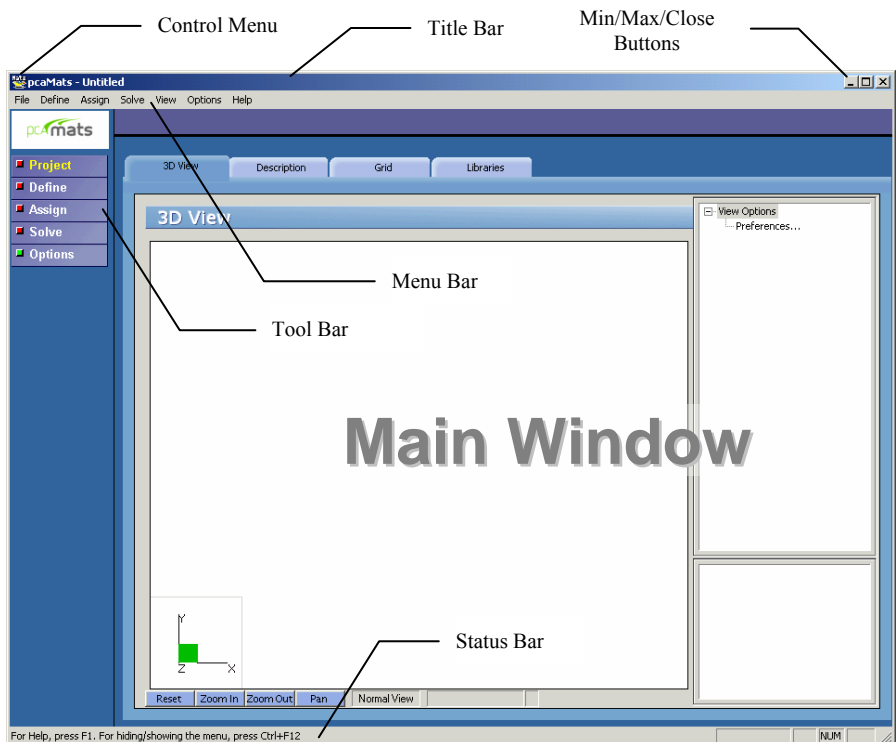

The Main Window is made of 4 distinct areas as illustrated here...

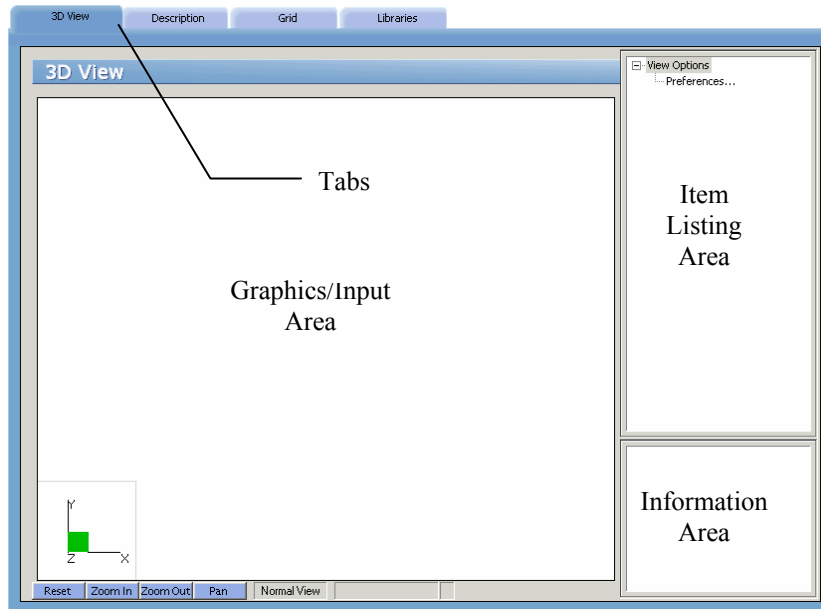



Control-Menu:

The *Control-Menu* is located in the upper-left corner of the screen. It includes commands for restoring, moving, sizing, minimizing, maximizing and closing the program.

Title Bar:

The *Title Bar* displays the name of the program (pcaMats 6 in this case), along with the path and filename of the current data file in use (D:\MATS EXAMPLES\EXAMPLE2.MA6 in this case.) If the file is new and has not yet been saved, the word *Untitled* is displayed in the title bar.

Min/Max/Close Buttons:

The *Min/Max/Close* buttons are located in the upper-right corner of the screen. The *Minimize* button () shrinks the program to the Windows Taskbar. The *Maximize* button () enlarges the program so that it covers the entire desktop. After the program has been maximized (takes up the entire screen), the *Maximize* button ()

is replaced by the *Restore* button (☐). Clicking on the *Restore* button (☐) returns the program to its original size.

Tool Bar:

The *Tool bar* is located on the left side of the screen. There are a total of 5 buttons on the tool bar each one displays various information in the *Main Window* of the program. The *Tool Bar* provides access to commands that are also accessible via the *Menu Bar*. The active tool bar’s text will appear in Yellow (highlighted).

Menu Bar:

The *Menu Bar* is located directly beneath the *Title Bar*. There are a total of 6 distinct drop-down menus accessible from the *Menu Bar*. The majority of commands appearing in the drop-down menus are also accessible via the program’s *Main Window* area.

Status Bar:

The *Status Bar* is located directly beneath the program’s *Main Window* area. It displays important information such as current units, cursor position, and helpful messages.

Tabs (on Main Window):

The *Tabs* are located on the *Main Window* and vary depending on the button you click on the *Tool Bar* or on the command that you select from one of the drop-down menus. Each *Tab* surfaces different GRAPHICS/INPUT AREAS for recording and inputting data as it relates to each project.

Graphics/Input Area (on Main Window):

The *Graphics/Input Area* covers most of the *Main Window*. This is where the graphical editing and data input is done.

Item Listing Area (on Main Window):

The *Item Listing Area* appears on the right side of the *Main Window*. The items appearing in the listing vary depending on the *Tab* that you select.

Certain items appearing in listings have “plus” or “minus” signs indicating that the list is expandable or retractable, respectively.



Information Area (on Main Window):

The *Information Area* appears in the lower-right corner of the *Main Window*. This area displays helpful information and values pertinent to the active item that you select in the *Item Listing Area*.

Using the Menus

To access a menu item with your mouse, bring the mouse pointer over the menu and left-click your mouse to have menu items appear within a drop-down menu. Then point to the menu item you wish to access and left-click your mouse again.

To access a menu item with your keyboard, simultaneously press the ALT key and the underlined letter of the menu containing the item you wish to access. Once the drop-down menu appears, you can either repeat the above step for the specific menu item, or use the up/down arrows on your keyboard, select the specific menu item, and press ENTER. For example, to access the Save menu item under the File menu, press ALT+F and then either press ALT+S or use the up/down arrows on your keyboard to select **S**ave before pressing ENTER.

Menu Conventions

The following menu conventions are used in pcaMats.

Menu Convention	Meaning
Dimmed (grayed out) command.	The command is currently unavailable.
An ellipse (...) following a command.	When the command is selected, a dialog box will appear requesting data input or listing options to select from.
A check mark (✓) next to a command.	The command is in effect. When the check mark is removed (by selecting the command), the command is no longer in effect.

Using a Dialog Box

A dialog box is displayed to request information or to supply you with information. A dialog box is usually displayed after you click on a button or request the program to do something specific such as “open” a data file. For example if you choose the **Open** command from the File menu, the OPEN dialog box will appear to float on top of the program as illustrated here...

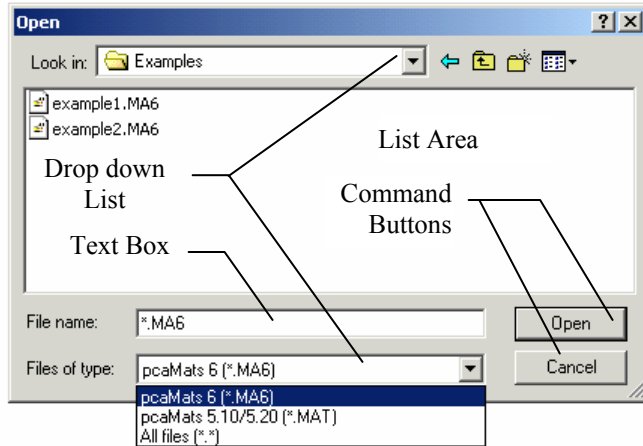

There are several options within various dialog boxes. The illustration above shows only a few.

Other options include “Radio Buttons” and “Check Boxes” as illustrated here...

To move from option to option within a dialog box using only your keyboard, press TAB and then use the arrow keys on your keyboard to select. To move backwards, press SHIFT+TAB.

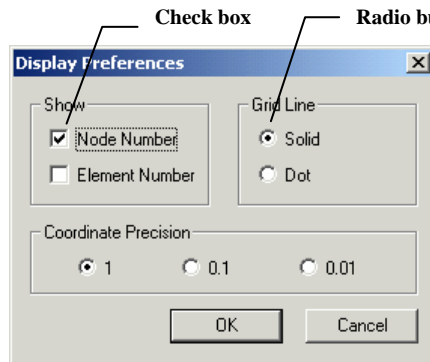

Using the Tool Bar

The Tool Bar located on the left side of the screen provides a fast and easy way to access commands or options without having to use the drop-down menus. The effect of clicking on any of the five buttons contained in the tool bar will be shown in the MAIN WINDOW.

The PROJECT button provides access to the following four tabs...

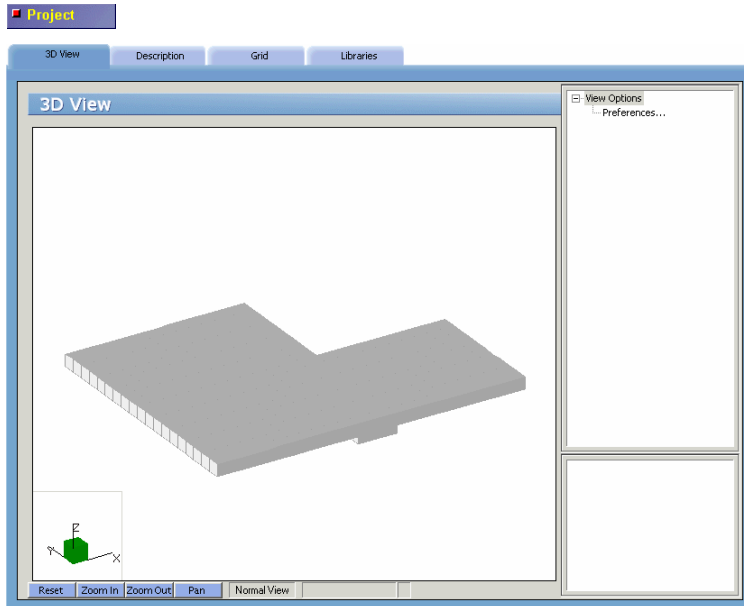

The ITEM LISTING AREA will provide further access to other commands or options.

The available commands and options will change depending on the tab that you click.

The remaining buttons and their respective relations are shown below...

Define

Properties Restraints Loads Load Combinations

Thickness

Label Thickness (in)

Thick1 23

Label	Thickness
Thick1	23.0000
Thick2	36.0000

Add
Delete
Modify

- Thickness
 - Thick1
 - Thick2
- Soil
- Concrete
- Reinforcement
- Design Parameters
- Column Dimensions

Assign

Properties Restraints Loads

Grid

- Thickness
 - Thick1
 - Thick2
- Soil
- Concrete
- Reinforcement
- Design Parameters
- Column Dimensions

Reset Zoom In Zoom Out Pan Normal View X = 8.52, Y = 35.19 R

Solve

Run Solver View Results View Contours Reports

Solver

Maximum number of iterations:

Maximum allowed displacement (in):

Minimum contact area (%):

Max uplift occurs for positive nodal displacement exceeding (in):

Compute required reinforcement based on

Maximum moment within an element

Average moment within an element

Options

Startup Autosave Display Statistics

Startup Defaults

Engineering Parameters

Units

English

Metric

Code

ADI 318-02

CSA-A23.3-94

Default Data Directory:

Default Library Directory:

No. of lines per printed page:

Working with a List Box

A List Box displays a list of choices. If there are more choices than can fit in the box, scroll bars will automatically appear either on the right or at the bottom of the list box allowing you to scroll through the list. To select an item from a list box, click the scroll arrows until the item you wish to select appears in the list box and then click on that item. If you are using the keyboard, use the arrow keys to scroll to the item you want.

To select a single item from a list box:

- Using the mouse, click the scroll arrows until the item you want to select appears in the list box. Click the item.
- Using the keyboard, press the UP or DOWN arrow key to scroll to the item you want.

To select multiple sequential items in a list:

- Using the mouse, click and hold down the left-mouse button on the first item you want to select and then drag the cursor to the last item you want to select. Alternatively, click on the first item you want to select, press and hold down the SHIFT key and click on the last item you want to select. Both items and all items in between are selected. To cancel the selections, release the shift key and click any item.

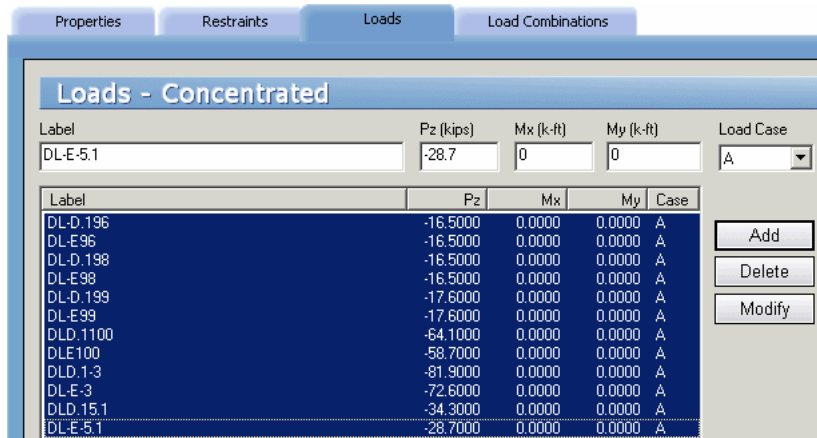

- Using the keyboard, press the UP or DOWN ARROW key to move the cursor to the first item you want to select. Press and hold down the SHIFT key and

continue to press the arrow key repeatedly until all the items you want are selected. To cancel the selections, release the SHIFT key and press one of the arrow keys.

To select multiple non-sequential items in a list:

- Using the mouse, press and hold down the CTRL key and click each item you want to select. To cancel the selection, press and hold down the CTRL key and click the item again

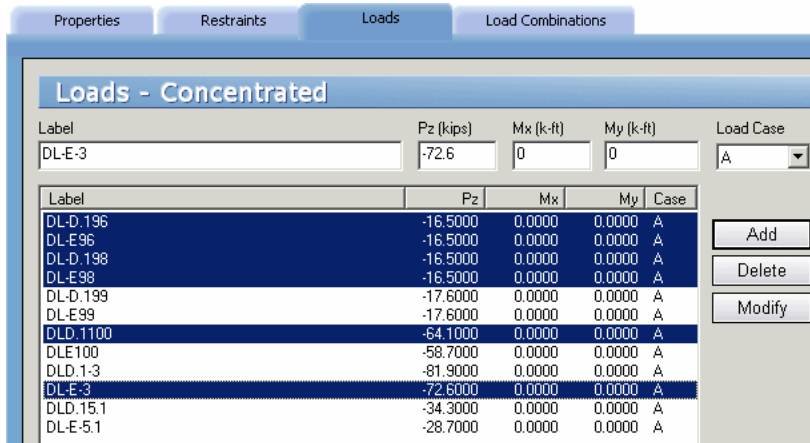

- Using the keyboard, press the UP or DOWN ARROW key to move the cursor to the first item you want to select. Press and hold down the CTRL key and press the SPACEBAR. Continue to press and hold down the CTRL key and use the arrow key until you get to the next item you want to select and then press the spacebar again. Repeat these steps until all items have been selected. To cancel the selections, simply release the CTRL key and press one of the arrow keys.

Working with a Drop-Down List

A Drop-Down list will appear as a rectangular box with the current selection marked and with the following symbol to the right of it...

To see a listing of available choices, click the symbol (arrow) or press DOWN ARROW on your keyboard. Make your selection in the appearing list by either clicking on it with the mouse or by selecting it with the DOWN ARROW on your keyboard.



Working with a Text Box

Text Boxes are where data or information is typed in. When you move into an empty text box, an insertion point (flashing vertical bar) appears. The text you type starts at the *insertion point*. If the box already contains text and you wish to overwrite it, simply select the text, delete it, and then type in the new text.

Using a Command Button

The Command Button (or PUSH BUTTON) is labeled to do exactly what it says. The OPEN, OK and CANCEL buttons are common command buttons. A command button followed by an ellipsis (...) opens another dialog box. The currently selected button has a darker border than other buttons displayed on the dialog box. The button may either be clicked on with the mouse or you may select it and press ENTER on your keyboard.



Using a Radio Button

The Radio Button is one of a group of related options in which you can select only one. When an option is selected, the selected option button will display a black dot. To select an option with the mouse, simply click the mouse button on the respective option. With the keyboard, press TAB to move to the group of options that contains the entry you want and then use the arrow keys to select the respective option.

Using a Check Box

The Check Box is an option that can be turned on or off. Unlike Radio Buttons, you can turn on as many check boxes as you like within one dialog box, even if they are all within a group. When a check box is turned on, an “X” appears in the box. If you are using a mouse, click a blank check box to select it or click a selected check box to clear it. If you are using a keyboard, press TAB to move to the checkbox and then press the SPACEBAR to either select or unselect the box.

Zooming and Translating while Assigning

While using any of the **Assign** menu or ASSIGN tool bar commands, the mouse action is reserved to select or deselect nodeas and elements. Note however that you may still zoom or translate the graphical image without selecting the corresponding commands from either the View menu or the bottom of the MAIN WINDOW.

Using the mouse:

By pressing and holding down a special key or key combinations, the mouse action switches to zoom or translate...

Key to press	Mouse action
SHIFT	Zoom in (left mouse button)
SHIFT	Zoom out (right mouse button)
SHIFT+CTRL	Translate
CTRL	Rotate (in 3D mode only)

File Menu

The **File** menu gives access to file operations, printing operations and to exiting the pcaMats program.

New

Clears any input data and returns the data to the default values so that a new data file may be input.

Open

Opens an existing data file.

Save

Saves the changes made to the current data file to disk.

Save As

Enables you to name or rename a data file.

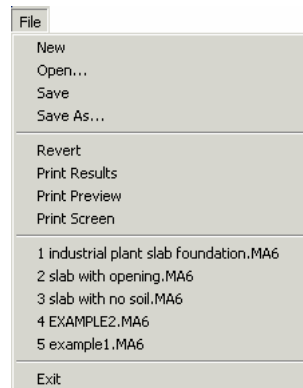

Revert

Discards any changes to the data file and returns to the most recently saved version of the data file. This option will only be available if the data file has been previously saved and there have been modifications done on the data file since. Do not save the data file immediately prior to reverting otherwise you will revert to nothing.

Print Results

Provides a printout of the input and output data.

Print Screen

Prints the graphical image displayed in the GRAPHICS/INPUT AREA of the MAIN WINDOW.

Exit

Ends the pcaMats program.

Define Menu

The **Define** menu provides access to commands used to define all of the input data. The information you input via the commands found under the Define menu will be used when assigning, and for calculating and designing the slab.

General Info

Defines and records the particulars on the project including project name and description, project date and time, and engineering parameters including units of measure and design code.

Grid

Defines the grid lines that make up the rectangular grid system. The slab model is defined based on the grid system specified here. This command also gives access to the grid preferences where you are able to show/hide node and element numbers, select between dotted or solid grid lines, and specify the coordinate precision.

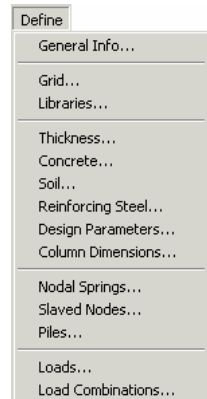

Library

Provides access to libraries from which data items can be imported to the current project or where data items can be recorded so they can be used in other projects.

Thickness

Defines the plate element thickness entries.

Concrete

Defines the concrete material properties including compressive strength, unit weight, Young's modulus and Poisson's ratio.

Soil

Defines soil properties including subgrade modulus and allowable pressure.

Reinforcing Steel

Defines reinforcing steel material properties including yield strength and Young's modulus.

Design Parameters

Defines the parameters that set the criteria for designing the slab. These parameters include minimum reinforcement ratio and distance of reinforcement from top and from bottom in both directions.

Columns

Defines column properties including type and cross section dimensions.

Nodal Springs

Defines nodal spring entries including the spring constant (K).

Slaved Nodes

Defines slaved nodes and their respective degrees of freedom (Dz, Rx, Ry).

Piles

Defines pile properties including pile type, cross section dimensions, pile length, material properties, and soil. These properties are used to calculate the equivalent spring constant for a pile.

Loads

Defines element and nodal load entries for up to six load cases (A to F).

Load Combinations

Defines load combinations for both service and ultimate levels under which the model is to be analyzed and designed.

Assign Menu

The Assign menu provides access to commands used to input the model geometry and assign the defined properties and loads to the nodes and elements. All assignments are done graphically.

Thickness

Assigns the various valid plate element thicknesses to the defined grid.

Concrete

Assigns the various concrete properties to the defined elements.

Soil

Assigns the various soil properties to the defined elements.

Reinforcing Steel

Assigns the various reinforcing steel properties to the defined elements.

Design Parameters

Assign the various design parameters to the defined elements.

Columns

Assign the various columns to the nodes.

Nodal Springs

Assigns the various nodal springs to the nodes.

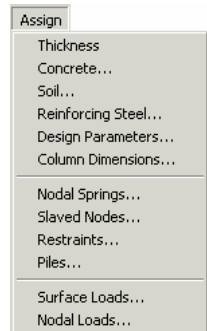

Slaved Nodes

Assigns the various slaved nodes that share the same degree of freedom.

Restraints

Assigns restraints for restraining nodal degrees of freedom.

Piles

Assign the various piles to the nodes.

Surface Loads

Assigns the various surface loads to the elements.

Nodal Loads

Assigns the various nodal loads to the nodes.

Solve

The Solve menu provides access to commands used to execute the analysis and design.

Execute

Executes the solver portion of the program.

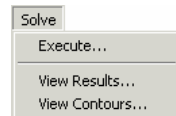
**View Results**

Provides access to the results after a successful run.

View Contours

Provides access to graphical representations after a successful run.

View Menu

The View menu provides access to commands used to manipulate the Graphical display and to control what is to be displayed in the GRAPHICS AREA.

3D

Toggles the model between isometric view and plan view.

Status Bar

Toggles the Status Bar at the bottom of the screen on or off.

This Menu (Ctrl+F12)

Toggles the Menu Bar at the top of the screen on or off.

Reset

Resets the graphical window to the default view. Zooming and Translating while Assigning

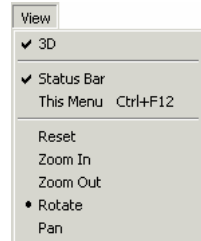

Zoom-in

Sets the graphical window in the zoom-in mode.

Zoom-out

Sets the graphical window in the zoom-out mode.

Rotate

Sets the graphical window in the rotate mode.

Pan

Sets the graphical window in the pan mode.

Options Menu

The Options menu provides access to commands used to save certain settings as defaults for subsequent new projects.

Startup defaults

Provides access to saving defaults such as Units of measurement and design code so that the system knows to use these for any future data file creations.

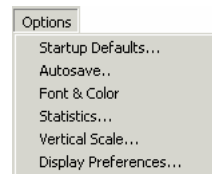

Autosave

Provides access to specify that the system automatically save data periodically without you having to necessarily select the File / Save command.

Font & Color

Provides access to specify the font used in displaying node and element numbers as well as access to modify the color settings of the Graphical display area.

Statistics

Provides access to information such as total number of nodes, elements, and definitions.

Vertical scale

Allows you to enter a factor for scaling the slab image along the Z-axis.

Display preferences

Provides access to turning on and off the display of node and element numbers, setting the grid line width, and specifying the precision of coordinates displayed in the graphics window.

Help Menu

The Help menu provides access to electronic support resources and to information on the pcaMats version.

Help Topics

Provides access to all available help topics. Click on any topic and a help screen will appear with information about that item.

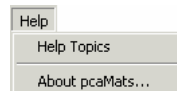

About pcaMats

Displays a message box displaying copyright information and the version number of pcaMats.

Chapter 4

Operating *pcaMats*

In this chapter, the sections follow the order in which commands and options appear under the subsequent menu items.

We begin with those found under the **File** menu and end with those under the **Help** menu.

Many of the commands and options that appear under these menus are also accessible by other methods. Consequently, these other methods are also explained.

Creating a New Data File

When *pcaMats* is first loaded, the program is ready to begin receiving input for a new project. Unless you save the file, the data will not have a filename associated with it, and the title bar will display the word *Untitled* as illustrated here...

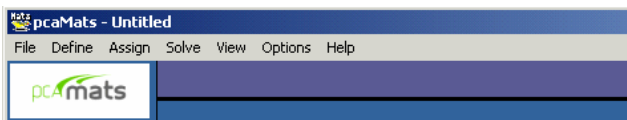

- From the **File** menu, choose **New**. This clears the screen in preparation for a new project or data entry file and returns the program to its default settings.
- If existing data on an open project has been changed prior to executing the **New** command, the program will display the following message box inquiring whether you wish to save the data on the open project or data file before creating a new file...

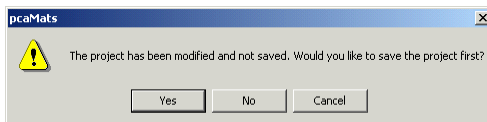

Opening an Existing Data File

From the **File** menu, choose **Open** to have the program display the following dialog box...

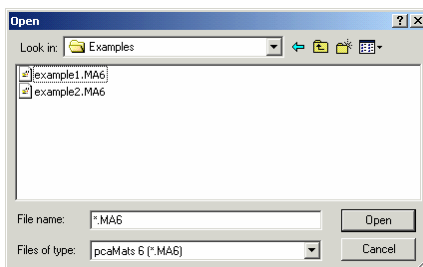

All files with MA6 extensions contained in the current drive and directory are displayed in the listing.

To open a MA6 file that exists in another drive or directory, use the LOOK IN drop-down list and locate the folder where the file exists. Once you locate the folder, the file will appear in the listing. From the white listing area, either select the file that is to be opened and click on the OPEN button, or simply double-click on the respective file.

You can also open data files with MAT extension that were created by the previous (5.10/5.20) versions of the program. Use FILES OF TYPE drop-down list to change the type of data files displayed in the OPEN dialog box and browse to the file you want to open.

Saving the Data

pcaMats files are saved in binary format with MAT extensions. When information in a data file is modified and until the file is saved, the Title bar will display the word (*Modified*) as illustrated here...

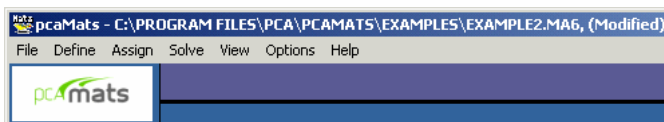

To save your data with the same filename:

- If you are editing an already existing data file and that file has previously been saved (i.e. the TITLE BAR displays a filename), then from the **File** menu,

choose the **Save** command. The changes will be recorded under the same filename and the old data file will be overwritten.

To save your data for the first time or to give an existing data file a new filename:

- If you are saving a new data file for the first time (i.e. the TITLE BAR displays *Untitled*), then when you choose **Save** or **Save As** from the **File** menu, the following SAVE AS dialog box will appear...

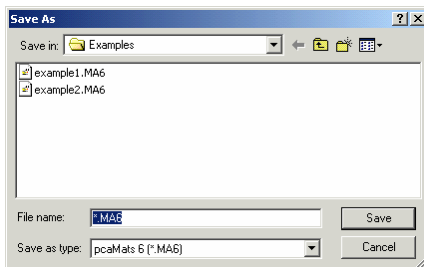

- Similarly, If you are editing an already existing data file and that file has previously been saved (i.e. the TITLE BAR displays a filename), and you wish to record the changes under a different filename, then choose **Save As** to have the program surface the SAVE AS dialog box.
- Use the SAVE IN drop-down list and locate the folder where the file is to be saved. Once you locate the folder, the white listing area will display any other pcaMats files that have been saved in that folder. Double-click in the FILE NAME text box and type a filename. (You need not enter an extension since, by default, the program will affix the MA6 extension to the filename.) Choose the SAVE button to finish recording the data file.

Reverting to the Last Saved Data File

- If you have begun to make changes to a data file that has previously been saved, (i.e. the TITLE BAR displays a filename), and you suddenly wish to discard all the changes and revert back to the previously saved data file, then from the File menu, select Revert.
- The program will verify your intention with the following message box...

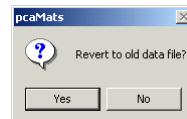



- Click on Yes only if you are certain that you wish to discard all changes since the last time the file was saved. If you are not sure, another option would be to actually save the file under a different name, and then re-open the old data file.

Note: If **Autosave** option is enabled the program will revert to the data previously saved by the **Autosave** function.

Printing Results

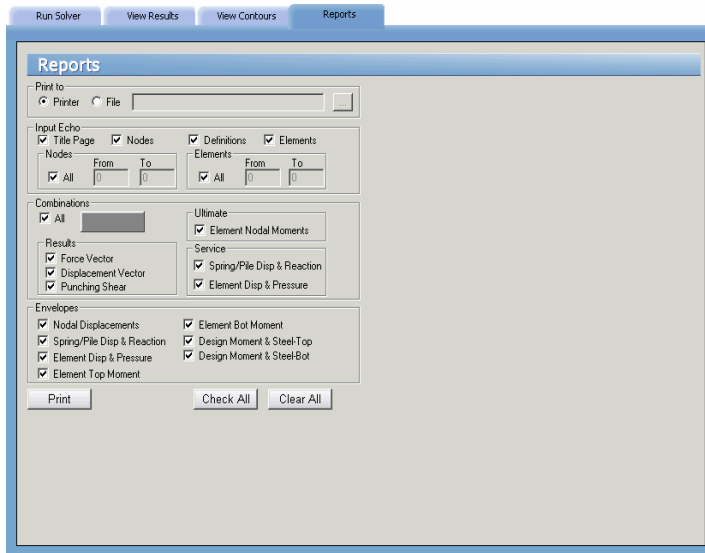
- From the **File** menu, choose **Print Results** to have the program surface the REPORTS folder as illustrated here...





Alternatively, you could have clicked on the  button located on the toolbar, and then on the REPORTS tab.

- Place a checkmark in the TITLE PAGE check box if you wish to include a title page with the printout.
- From the INPUT ECHO group, you may select the tables to be printed...

DEFINITIONS: Will print all the input data entered using the **Define** menu commands.

NODES: Will list all nodal data including coordinates, assignments and loads.

ELEMENTS: Will print all element indexes, assignments and loads.

- Select the RESULTS to be printed. (Force Vector and/or displacement Vector)
For more information about the output tables, see *Program Results* in Chapter 2.
- In the SERVICE group, select whether to display SPRING DISPLACEMENT & REACTIONS and/or ELEMENT DISPLACEMENT & PRESSURE. If check marked, the program will display the respective results under the service load calculations.
- In the ULTIMATE group, select whether to display ELEMENT NODAL MOMENTS. If check marked, the program will display the respective results under the ultimate load calculations.
- Place a check mark in PUNCHING SHEAR if you wish the output to include the respective results of the Punching Shear computations.
- In the NODES and ELEMENTS groups, select the ALL check box for a comprehensive output. For selective printing, specify the range of nodes and/or elements to print for.
- In the COMBINATIONS group, select ALL to print for all service and ultimate load combinations. To print for specific combinations, choose the SELECT button to have the program surface the following dialog box...
- Highlight the combinations from the DEFINED COMBINATIONS list, and click on the  button to move them to the SELECTED COMBINATIONS list. Repeat for all load combinations you wish to select under both SERVICE and ULTIMATE. To remove a selected combination, highlight the combination from the SELECTED COMBINATIONS list and click on the  button. Click on the OK button when done.
- Choose the ENVELOPES that are to be included in the output (printout).
- Alternatively, CHECK ALL button can be used to include all items in the printout. Clicking on the CLEAR ALL button will clear all selected items.

- In the PRINT TO group, specify whether the output should be sent to the default printer or if it should be saved to a file. If FILE is selected, click on the  button to specify what it should be named and where it should be saved.
- Click on the PRINT button.

Printing the screen

- From the **File** menu, choose **Print Screen** to have the program surface the standard Windows print dialog box similar to the following....
- This command will print the GRAPHICS AREA in a WYSIWYG format. In order for this command to be enabled, the **3D View** folder must be the active folder...

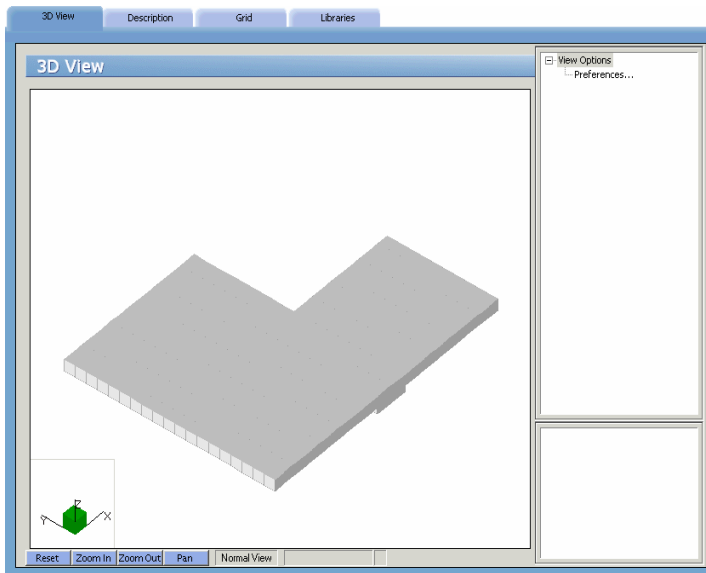
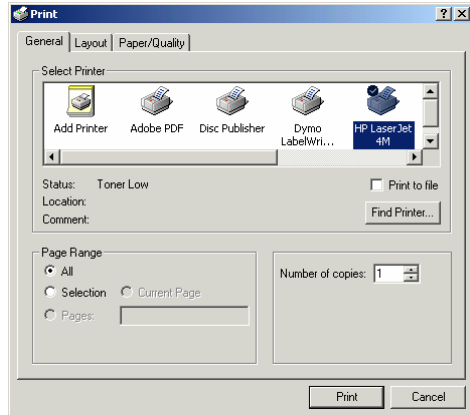

Exiting the Program

From the **File** menu, choose **Exit**. If the data file has been modified since the last time it was saved, i.e. the word (*Modified*) appears in the TITLE BAR, then the program will display the following message box...

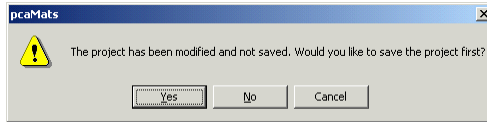

Click on YES to save. NO will exit without saving, and CANCEL will ignore the **Exit** command and return you to the data file.

Defining the General Info

- From the **File** menu, choose **Exit**. If the data file has been modified since the last time it was saved, i.e. the word (*Modified*) appears in the TITLE BAR), then the program will display the following message box...

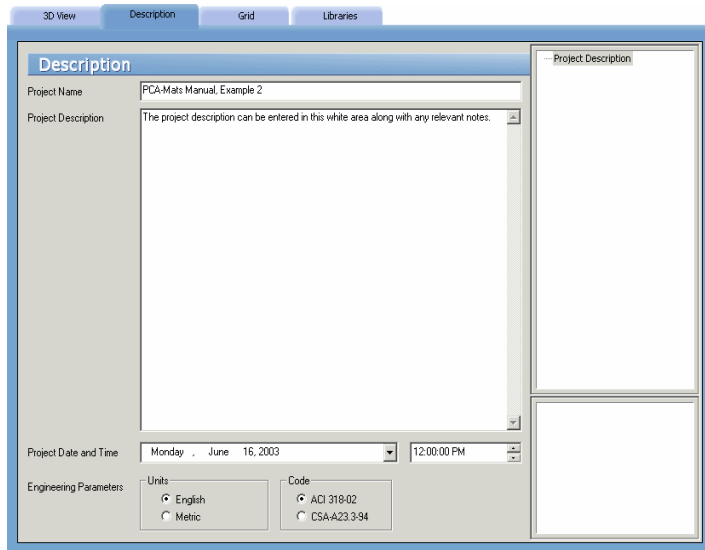

- Click on YES to save. NO will exit without saving, and CANCEL will ignore the Exit command and return you to the data file.

- From the **Define** menu, choose **General Info** to have the program surface the DESCRIPTION folder as illustrated here...

Alternatively, you could have clicked on the  button located on the toolbar, and then on the DESCRIPTION tab.

- Enter the Project Name and any details/notes describing the project (PROJECT DESCRIPTION). The Project Date And Time will default to the instance you started the project however you are free to change it. These fields help organize and identify data sets.
- From the UNITS options group, choose the applicable units of measure and from the CODE options group, select the appropriate design code.

Defining the Grid

- The rectangular grid system is defined by inputting the coordinates of the X and Y grid lines. Note that it is possible to generate multiple, equally spaced grid lines as well as individual ones at any location.
- From the **Define** menu, choose **Grid** to have the program surface the GRID folder as illustrated here...

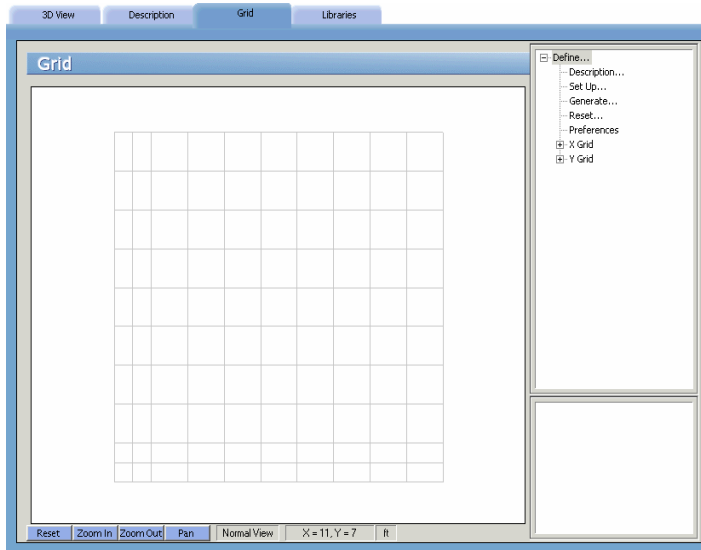

- Alternatively, you could have clicked on the **Project** button located on the toolbar, and then on the GRID tab.
- If you wish, you can enter a name and description for the grid. To do this, double-click on DESCRIPTION... found in the right item listing area. The program will surface the following dialog box...
- Enter a NAME and DESCRIPTION or note and click on OK.

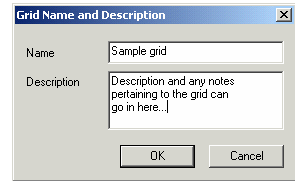

To Enter Grid Lines Individually:

- Double-click on SET UP... found in the right ITEM LISTING AREA to have the program surface the following...
- Select the grid direction from the respective option group, X-Direction or Y-Direction. Grids in the X-Direction are perpendicular to the X-axis and those in the Y-Direction are perpendicular to the Y-axis.
- Enter a grid line coordinate. This value, in feet or meters, represents the orthogonal distance from the origin to the grid line.
- Choose the ADD button to add the grid coordinate to the listing area.
- Repeat the two steps above for each grid line.
- If you wish to enter grids separately and individually in the other direction then repeat the above four steps. If you wish to copy the grids you just input in one direction so that they are mirrored in the other direction, choose the COPY button. For example, if you just finished defining the grid lines in the X-Direction then the COPY button will copy all X-grid lines to Y-Direction.

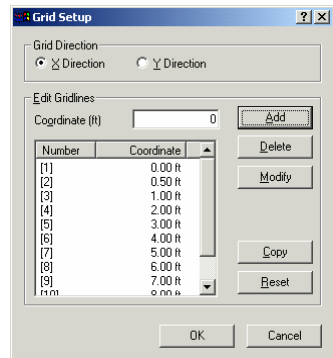

To Delete Grid Lines:

- Select the grid line you wish to delete and choose the DELETE button.

To Edit the Position of a Grid Line:

- Select the grid line you wish to edit, change its location by overwriting the value that is displayed in the COORDINATE text box and choose the MODIFY button.

To Generate Grid Lines:

Grid Lines that are spaced at equal intervals may be generated by inputting the coordinate (distance from the origin) of the first grid line, the number of grid lines and the spacing between two consecutive grid lines.

- With the GRID tab surfaced, double-click on GENERATE... found in the right ITEM LISTING AREA to have the program surface the following...
- To generate grids in the X-direction, place a checkmark in the X-Direction checkbox. To generate grids in the Y-Direction, place a checkmark in the Y-Direction check box. Recall that grids in the X-Direction are perpendicular to the X-axis and those in the Y-Direction are perpendicular to the Y-axis.
- For each direction, enter the coordinate of the first grid line to be generated, the number of grid lines to be generated (including the first one) and the spacing between two consecutive grid lines.
- Click on the GENERATE button to have the program generate the respective grid lines.

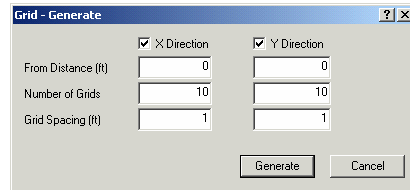

To Remove all the Grid Lines:

- Double-click on RESET... found in the right ITEM LISTING AREA to have the program surface the following...
- Note that if you choose to proceed, any material properties, loads, etc. that have already been assigned will have to be re-assigned.
- After confirming your intention, all the grid lines will be removed.

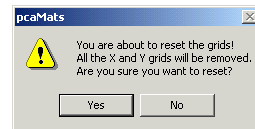

To Choose the Grid View Preferences:

- Double-click on PREFERENCES... found in the right ITEM LISTING AREA to have the program surface the following...

- If you wish for the grid to display the NODE NUMBERS and/or the ELEMENT NUMBERS, place checkmarks in the appropriate box(es).
- Select the style of the grid line, SOLID or DOTTED.
- Specify the COORDINATE PRECISION. This value relates to the precision of the cursor location. (Recall that the location of the cursor is displayed in the STATUS BAR.)
- Click on OK to register your selections/changes.

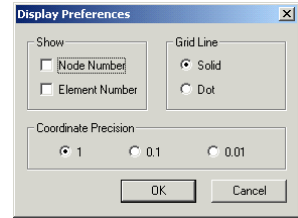

To View the Grid Coordinates:

In the right ITEM LISTING AREA, click on the symbol next to the X GRID or Y GRID item(s) to expand the list of grid coordinates. Notice how the grid that is selected appears in red in the GRAPHICS/INPUT AREA.

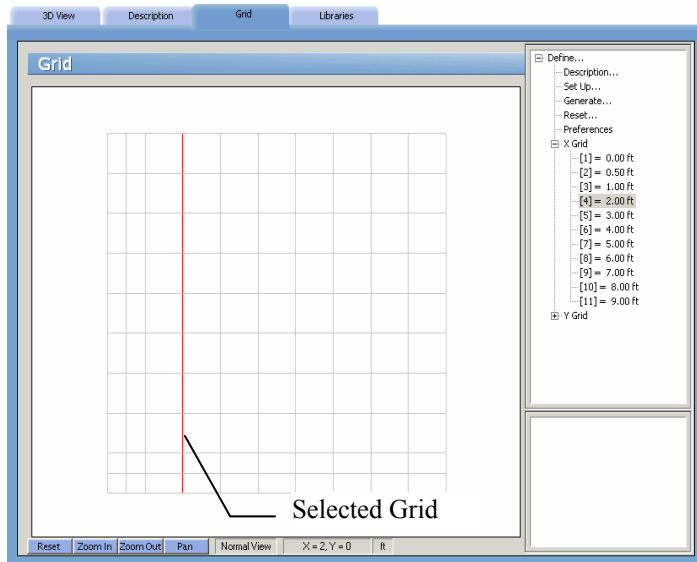

Managing Libraries

The following items may either be recorded during the definition of the project, or they may be assigned to the project from existing libraries:

- *Grids*
- *Element thickness*
- *Soil properties*
- *Concrete properties*
- *Reinforcement properties*
- *Design parameters*
- *Columns*
- *Nodal Springs*
- *Slaved Nodes*
- *Piles*
- *Concentrated loads*
- *Surface loads*
- *Load Combinations*

Newly defined items may also be added to existing libraries, or may be saved as part of a new library for use on any future projects.

Items may also be extracted and applied to the current project from numerous libraries (i.e. Element thickness 1 and 2 from Library A, and element thickness 3 and 4 from Library B)

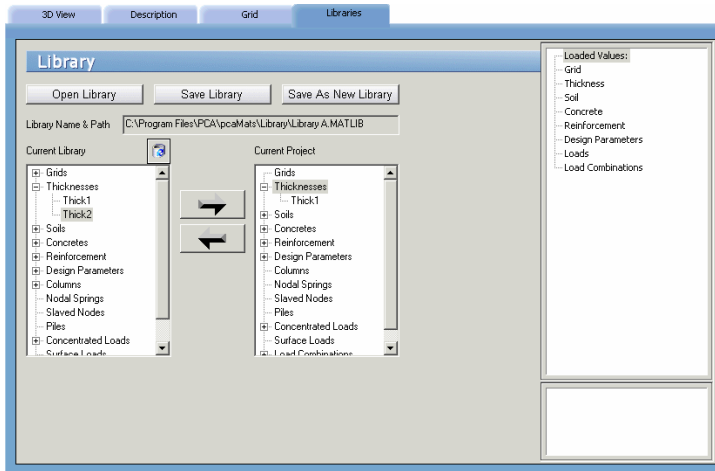

The file extension of pcaMats library files is: *.MATLIB

- From the **Define** menu, choose **Library** to have the program surface the LIBRARIES folder as illustrated here...





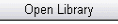

Alternatively, you could have clicked on the **Define** button located on the toolbar, and then on the PROPERTIES tab.

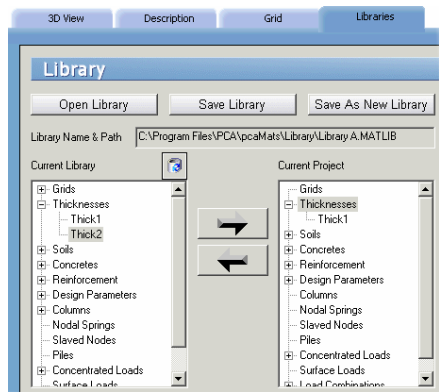
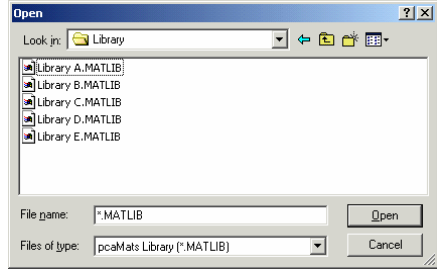
To Assign Items from a Library to the Current Project:

- Click on the  button to have the following Windows OPEN dialog box appear...
- Locate the library file and click on OPEN to return focus to pcamats. Notice how the contents of the selected library appear in the listing under “Current Library”...
- Click on the  symbol next to various items to expand their contents. The items that will subsequently appear are items that have been pre-defined.
- Select the item and click on the  arrow to copy the item and to paste it into the current project. Any items copied over now become available for assigning.
- Repeat the above steps to select items from additional libraries.

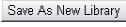

To Create and Save a Library:

- Click on the  symbol next to the items appearing under the Current Project listing to expand their contents.
- Locate the specific items defined in the current project and click on the  arrow to copy the item and to paste it into the current library.
- If there are items in the library that you would like to remove, simply highlight (click on) them and click on the  icon
- To overwrite the library, click on the  button. Any items copied over from the current project now become part of the saved library.
- To save the library as new, click on the  button. Any items copied over from the current project now become part of the new library.

Defining material Properties

Material properties such as:

- element thickness,
- soil modulus (K_s) and allowable pressure (Q_a),
- concrete compressive strength (f'_c), unit weight (w), Young's modulus (E_c), and Poisson's ratio (ν),
- reinforcement yield strength (f_y), Young's modulus (E_s), minimum reinforcement ratio and re-bar location,
- column type (round or rectangular) and dimensions, must be defined before they can be assigned to the elements on the grid.
- From the **Define** menu, choose **Thickness**, **Concrete**, **Soil**, **Reinforcing Steel** or **Design Parameters** to have the program surface the PROPERTIES folder as illustrated here...

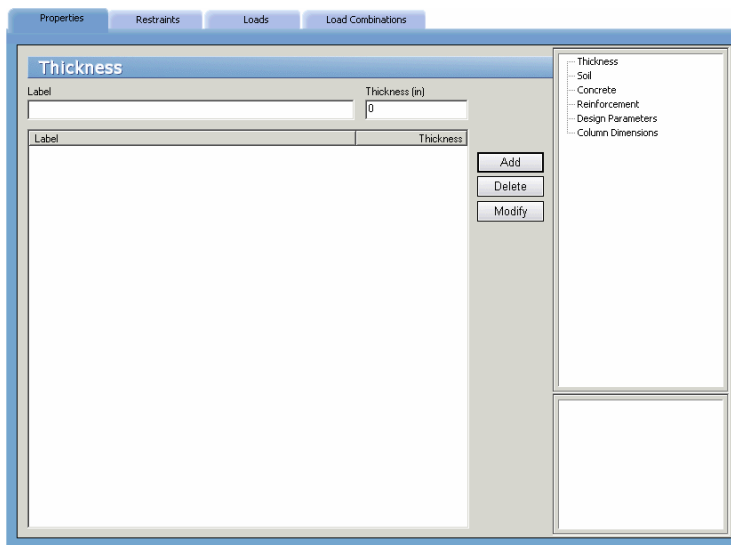

Alternatively, you could have clicked on the **Define** button located on the toolbar, and then on the PROPERTIES tab.

To define the Element Thickness

- From the **Define** menu select **Thickness**, or if the PROPERTIES folder is displayed, click on THICKNESS... found in the right ITEM LISTING AREA to have the program surface the Thickness input screen...

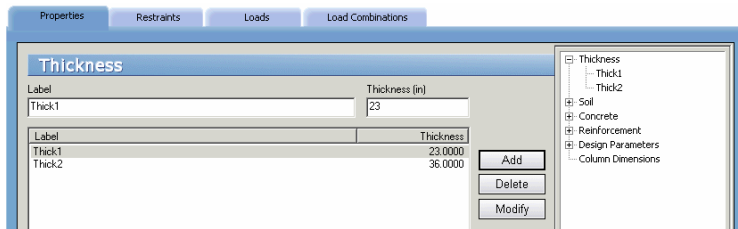

- Enter a thickness label or ID in the LABEL text box and enter the corresponding thickness in the THICKNESS text box.
- Click on the ADD button to add the entry to the list box.
- Repeat the two steps above for each thickness entry.
- To edit an entry, select it from the list box, modify its value(s) in the text box(es) and click on the MODIFY button to register the changes.
- To delete a thickness entry, select it from the list box and click on the DELETE button.

To Define the Soil Properties:

- From the **Define** menu select **Soil**, or if the PROPERTIES folder is displayed, click on **Soil...** found in the right ITEM LISTING AREA to have the program surface the Soil input screen...

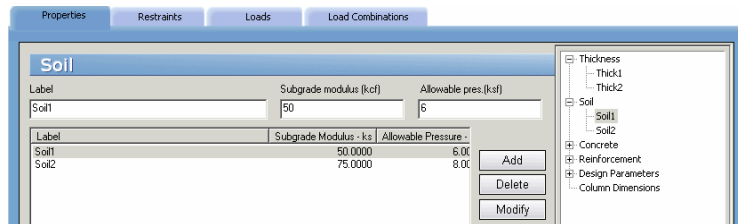

- Enter a label or Soil ID in the LABEL text box and enter the corresponding SUBGRADE MODULUS (K_s) and soil's ALLOWABLE PRESSURE (Q_a) in the corresponding text boxes.

- Click on the ADD button to add the entry to the list box.
- Repeat the two steps above for each soil entry.
- To edit an entry, select it from the list box, modify its value(s) in the text box(es) and click on the MODIFY button to register the changes.
- To delete a soil entry, select it from the list box and click on the DELETE button.

To Define the Concrete Properties:

- From the **Define** menu select Concrete, or if the PROPERTIES folder is displayed, click on CONCRETE... found in the right ITEM LISTING AREA to have the program surface the Concrete input screen...

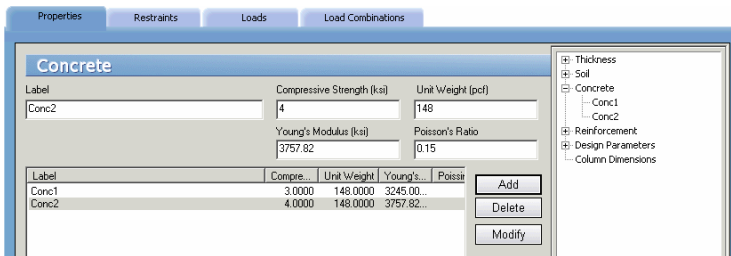

- Enter a label or Concrete ID in the LABEL text box and enter the corresponding Compressive Strength (f'_c) and UNIT WEIGHT (w) in the respective text boxes.
- The YOUNG'S MODULUS of elasticity (E_c) is calculated automatically and will display a result that is respective of the equations in the selected Code. Note that the value of E_c can be modified if it differs from the calculated value.
- Enter the POISSON'S RATIO for the concrete and click on the ADD button to add the entry to the list box.
- Repeat the three steps above for each concrete entry.
- To edit an entry, select it from the list box, modify its value(s) in the text box(es) and click on the MODIFY button to register the changes.
- To delete a concrete material entry, select it from the list box and click on the DELETE button.

To Define the Reinforcing Steel Properties:

- From the **Define** menu select **Reinforcing Steel**, or if the PROPERTIES folder is displayed, click on REINFORCEMENT... found in the right ITEM LISTING AREA to have the program surface the Reinforcement input screen...

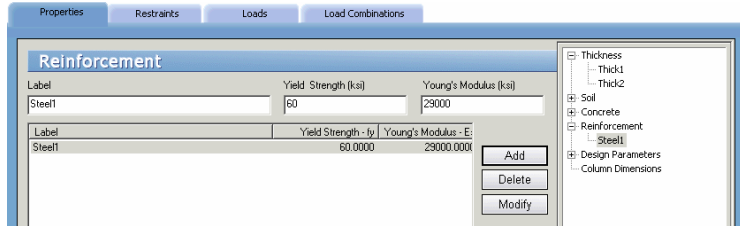

- Enter a label or Reinforcement ID in the LABEL text box and enter the corresponding Yield Strength (f_y) and the YOUNG'S MODULUS of elasticity (E_s) for the steel.
- Click on the ADD button to add the entry to the list box.
- Repeat the two steps above for each reinforcement entry.
- To edit an entry, select it from the list box, modify its value(s) in the text box(es) and click on the MODIFY button to register the changes.
- To delete a reinforcement material entry, select it from the list box and click on the DELETE button.

To Define the Design Parameters:

- From the **Define** menu select **Design Parameters**, or if the PROPERTIES folder is displayed, click on DESIGN PARAMETERS... found in the right ITEM LISTING AREA to have the program surface the Design Parameters input screen.
- Enter a label or ID in the LABEL text box and enter the corresponding MINIMUM REINFORCEMENT RATIO as a percentage of the gross area.
- Specify the bar cover for the TOP and BOTTOM bars running in the X and Y directions. For top bars, the cover is measured from the slab top to the centroid of the bar. For bottom bars, the cover is measured from the slab bottom to the centroid of the bar.

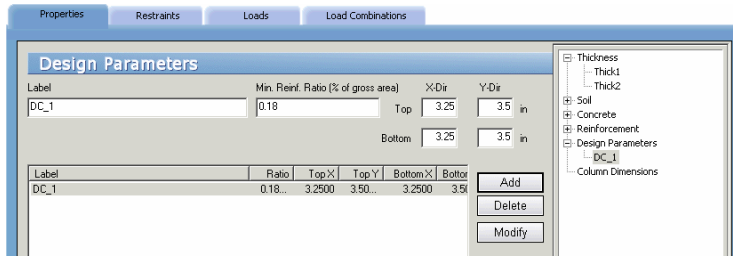

- Click on the ADD button to add the entry to the list box.
- Repeat the three steps above for each design entry.
- To edit an entry, select it from the list box, modify its value(s) in the text box(es) and click on the MODIFY button to register the changes.
- To delete a design parameter entry, select it from the list box and click on the DELETE button.

To Define the Column Dimensions:

- Surface the PROPERTIES folder and click on COLUMN DIMENSIONS... found in the right ITEM LISTING AREA to have the program surface the Column Dimensions input screen...

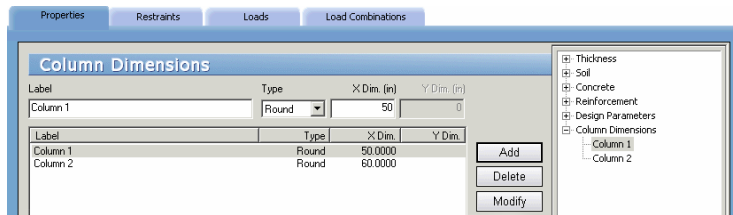



- Enter a label or Column ID in the LABEL text box and select the TYPE of COLUMN (Round or Rectangle) from the drop-down list.
- Enter the dimensions in the respective text box(es). If you select "Round" from the TYPE drop-down list, then enter the column's diameter as the X-DIM.
- Click on the ADD button to add the column to the list box.
- Repeat the three steps above for each column entry.
- To edit an entry, select it from the list box, modify its value(s) in the text box(es) and click on the MODIFY button to register the changes.

- To delete a column entry, select it from the list box and click on the DELETE button.

Defining the Restraints

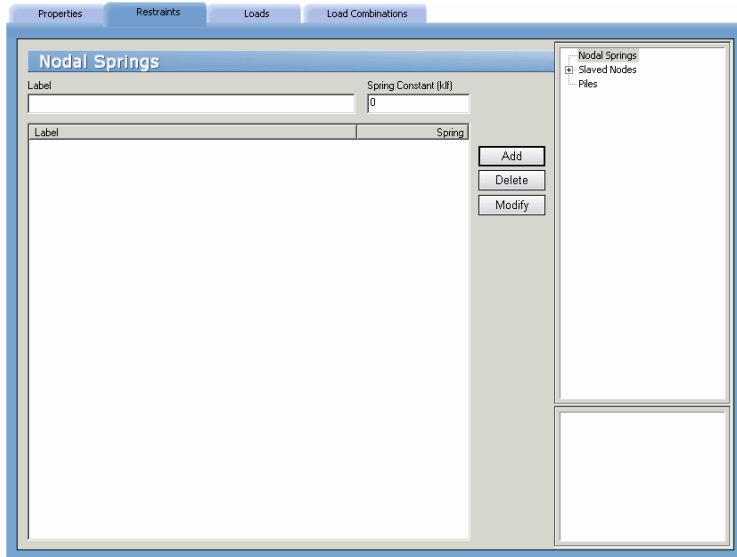
From the Define menu, choose **Nodal Springs** or **Slaved Nodes** to have the program surface the RESTRAINTS folder as illustrated here...



Alternatively, you could have clicked on the  **Define** button located on the toolbar, and then on the RESTRAINTS tab.

To Define the Nodal Springs:

- From the **Define** menu select **Nodal Springs**, or if the RESTRAINTS folder is displayed, click on NODAL SPRINGS... found in the right ITEM LISTING AREA to have the program surface the **Nodal Springs** input screen.
- Enter a label or Nodal Spring ID in the LABEL text box and enter the corresponding Spring Constant.
- Click on the ADD button to add the entry to the list box.
- Repeat the two steps above for each Nodal Spring entry.

- To edit an entry, select it from the list box, modify its value(s) in the text box(es) and click on the MODIFY button to register the changes.
- To delete a Nodal Spring entry, select it from the list box and click on the DELETE button.

To Define the Slaved Nodes:

Slaved nodes are nodes that share a particular degree of freedom (Dz, Rx or Ry). A slaved node group must first be defined and then the nodes to be included in the group are assigned using the **Assign / Slaved Nodes** command. A group is defined by giving it a label and a degree of freedom.

- From the **Define** menu select **Slaved Nodes**, or if the RESTRAINTS folder is displayed, click on SLAVED NODES... found in the right ITEM LISTING AREA to have the program surface the Slaved Nodes input screen...

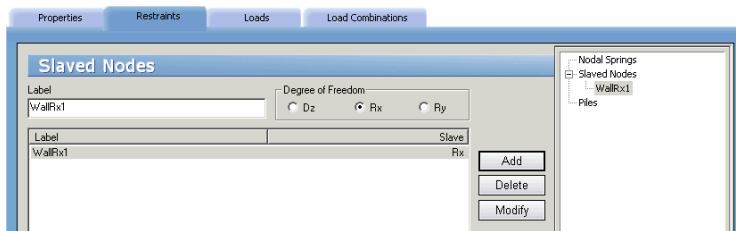

- Enter a label or Slaved Node ID in the LABEL text box.
- From the Degree of Freedom option group, select the degree of freedom that the slaved nodes will share, displacement in the Z-direction (Dz), rotation about the x-axis (Rx), or rotation about the Y-axis (Ry).
- Click on the ADD button to add the entry to the list box.
- Repeat the three steps above for each slaved node group.
- To edit an entry, select it from the list box, modify its value(s) in the text box(es) and click on the MODIFY button to register the changes.
- To delete a slaved node group, select it from the list box and click on the DELETE button.

To Define the Piles:

- Surface the RESTRAINTS folder and click on PILES... found in the right ITEM LISTING AREA to have the program surface the Piles input screen.

- Enter a label or Pile ID in the LABEL text box and enter the corresponding Spring Constant.
- Click on the ADD button to have the program surface the following dialog box...
- Enter a Label for the pile and from the PILE TYPE drop-down list, select between ROUND, SQUARE, RECTANGULAR and H-TYPE.
- What you select in the PILE TYPE drop-down list dictates the fields that will be made available for the PILE DIMENSIONS. Use the image that will be displayed just underneath the PILE TYPE selection as a guide when filling out the Pile Dimensions.
- Select the Pile Material by choosing CONCRETE, STEEL, or PRECAST from the respective drop-down list.
- Use the SELECT SOIL drop-down list to select the soil. Recall that the soil and its corresponding properties are defined by you. (See *To Define the Soil Properties*, explained earlier.)
- Click on the OK button to close the dialog box and to return focus to the Piles folder. Notice how the pile has been added as an entry to the list box.
- Repeat the seven steps above for each Pile entry.
- To edit an entry, select it from the list box, if you wish to modify its LABEL or SPRING CONSTANT, simply edit the values in the respective text boxes and click on the MODIFY button to register the changes. If you wish to edit the TYPE, DIMENSIONS, SOIL TYPE, or PILE MATERIAL, click on the EDIT button to surface the corresponding dialog box, modify the value(s) in the text box(es) and then click on the OK button to close the dialog box and to return focus to the Piles folder.
- To delete a Pile entry, select it from the list box and click on the DELETE button.

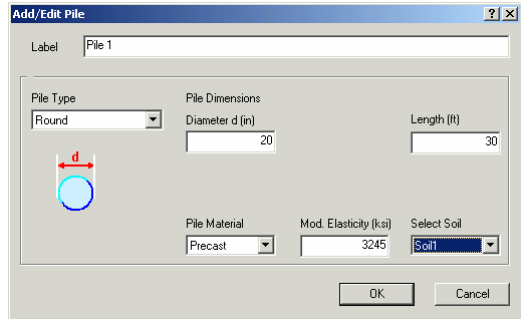

Defining the Loads

Nodal and element loads are defined using the **Define / Loads** command. They are then assigned to the nodes using the **Assign / Nodal Loads** command, and to elements using the **Assign / Surface Loads** command.

- From the **Define** menu, choose **Loads** to have the program surface the LOADS folder.

Alternatively, you could have clicked on the  button located on the toolbar, and then on the LOADS tab.

To Define the Concentrated Load(s):

- Surface the LOADS folder and click on CONCENTRATED... found in the right ITEM LISTING AREA to have the program surface the Concentrated Loads input screen...

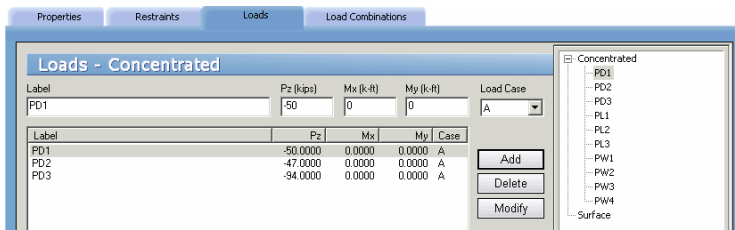

- Enter a label or Concentrated Load ID in the LABEL text box.
- From the Case drop-down list, select a load case (A through F). Note that loads defined under a particular load case may be applied to the slab under that load case only.
- Enter an axial force (P_z), a moment about the X-axis (M_x), and a moment about the Y-axis (M_y). Note that downward forces (P_z) have a negative value. To determine the direction of the moments M_x and M_y , use the right hand rule.
- Click on the ADD button to add the concentrated load to the list box. Note that the data in the list box are sorted by type and case. Only loads of the same type and case are listed together.
- Repeat the four steps above for each concentrated load.
- To edit an entry, select it from the list box, modify its value(s) in the text box(es) and click on the MODIFY button to register the changes.

- To delete a load entry, select it from the list box and click on the DELETE button.

To Define the Surface Load(s):

- Surface the LOADS folder and click on SURFACE... found in the right ITEM LISTING AREA to have the program surface the Surface Loads input screen...

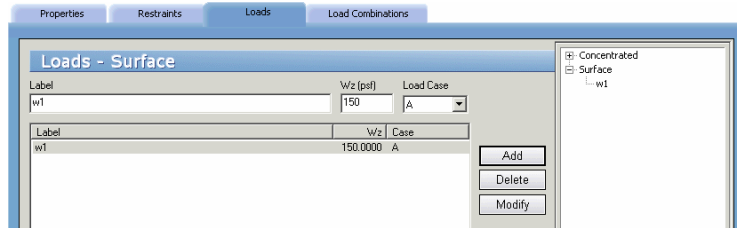

- Enter a label or Surface Load ID in the LABEL text box.
- From the Case drop-down list, select a load case (A through F). Note that loads defined under a particular load case may be applied to the slab under that load case only.
- Enter the load intensity W_z as a force per unit area. Note that downward forces (W_z) have a negative value.
- Click on the ADD button to add the surface load to the list box. Note that the data in the list box are sorted by type and case. Only loads of the same type and case are listed together.
- Repeat the four steps above for each surface load entry.
- To edit an entry, select it from the list box, modify its value(s) in the text box(es) and click on the MODIFY button to register the changes.
- To delete a load entry, select it from the list box and click on the DELETE button.

Defining the Load Combinations

Loads are applied to nodes and elements under six load cases (A through F). The load cases are combined under load combinations and the analysis is performed for each load combination.

- From the **Define** menu, choose **Load Combinations** to have the program surface the LOAD COMBINATIONS folder as illustrated here...

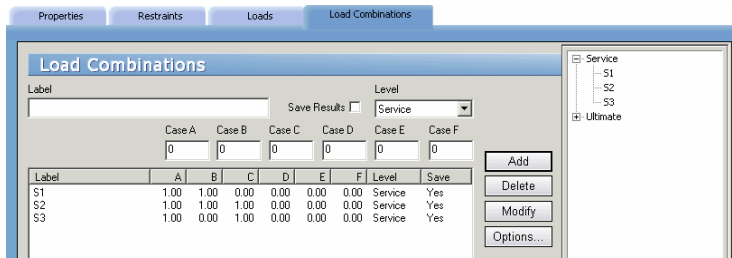

- Alternatively, you could have clicked on the **Define** button located on the toolbar, and then on the LOAD COMBINATIONS tab.
 - Enter a label or Load Combination ID in the LABEL text box, and select a combination LEVEL, (Service or Ultimate). Deflections are output for all combinations. Pressures and spring reactions are output for Service level combinations. Design moments and required reinforcement are output for *Ultimate* level load combinations. Envelope results are computed for *all service* combinations as well as for *all ultimate* combinations.
 - Enter load factors for each load case (A through F) and click the ADD button to add the load combination to the list box.
 - Once all the load combinations have been defined, click on the OPTIONS button to have the program surface the following dialog box...
-
- Check or clear the SAVE COMBINATION RESULTS option. Results for individual combinations are saved to disk only if this option is checked. Envelope results are always saved to disk regardless of the status of this option. Check or clear the INCLUDE SELF-WEIGHT IN CASE A option. If this option is checked, the self-weight of the slab will be automatically computed and included under load case A.
 - Repeat the four steps above for each load combination entry.
 - To edit an entry, select it from the list box, modify its value(s) in the text box(es) and click on the MODIFY button to register the changes.
 - To delete a load combination, select it from the list box and click on the DELETE button.

Assigning the material properties

Once the grid, all components, material properties, design parameters, loads and load combinations have been defined, you are ready to start assigning them - thereby putting the project together.

- From the Assign menu, choose **Thickness, Concrete, Soil, Reinforcing Steel** or **Design Parameters** to have the program surface the PROPERTIES folder as illustrated here...

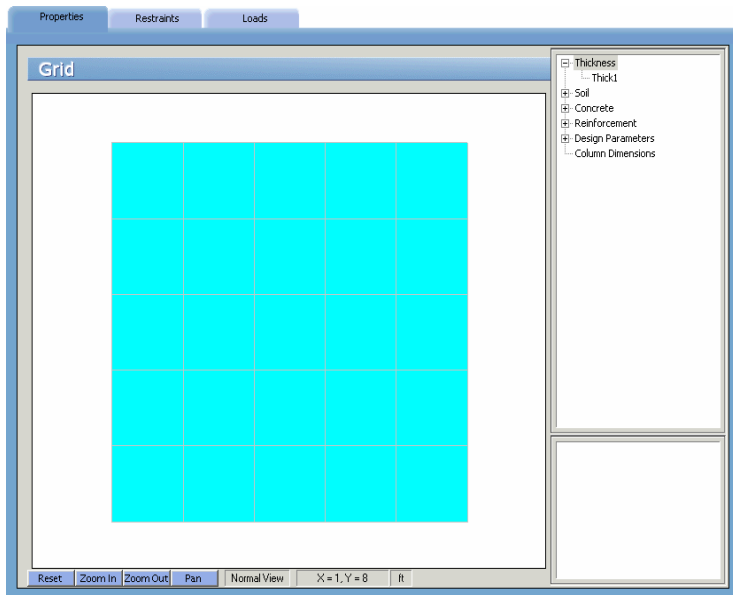

Alternatively, you could have clicked on the **Assign** button located on the toolbar, and then on the PROPERTIES tab.

To Assign the Element Thickness:

- From the **Assign** menu, choose **Thickness**, or if the PROPERTIES folder is displayed, click on the **+** symbol next to THICKNESS... found in the right ITEM LISTING AREA to expand the THICKNESS list. The thicknesses that will appear are those defined using the **Define / Thickness** command. See *To Define The Element Thickness*.

- Select the thickness to be assigned. This becomes the active assignment. By default, the program will display all elements that share the active assignment in red and the inactive assignment in cyan. Unassigned grid space is by default displayed in white. Recall however that you may change the color preferences to your liking with the **Options / Font & Color** command. See *To Change The Font and Color Preferences*.
- In the GRAPHICS AREA, using the left-mouse button, marquee select a grid space or a group of grid spaces (or click a single grid space). The selected grid spaces are shown in red or in the color specified for ACTIVE OBJECTS in the FONT & COLOR folder. See *To Change The Font and Color Preference*.
- To delete an element, remove its thickness assignment. To do so, repeat the step above using instead, the right mouse button.
- Repeat the three steps above for each thickness entry.

To Assign the Soil Properties:

- From the **Assign** menu select **Soil**, or if the PROPERTIES folder is displayed, click on the  symbol next to SOIL... found in the right ITEM LISTING AREA to expand the SOIL list. The soils that will appear are those defined using the **Define / Soil** command. See *To Define The Soil Properties*.
- Select the soil to be assigned. This becomes the active assignment. By default, the program will display all elements that share the active assignment in red and the inactive assignment in cyan. Unassigned elements are by default displayed in powder blue. Recall however that you may change the color preferences to your liking with the **Options / Font & Color** command. See *To Change The Font and Color Preferences*.
- In the GRAPHICS AREA, using the left-mouse button, marquee select an element or a group of elements (or click a single element). The selected elements are shown in red or in the color specified for ACTIVE OBJECTS in the FONT & COLOR folder. See *To Change The Font and Color Preference*.
- To remove a soil assignment, repeat the step above using instead, the right mouse button.
- Repeat the three steps above for each soil entry.

To Assign the Concrete Properties:

- From the Assign menu select Concrete, or if the PROPERTIES folder is displayed, click on the  symbol next to CONCRETE... found in the right ITEM LISTING AREA to expand the CONCRETE list. The concrete that will appear are those defined using the **Define / Concrete** command. See *To Define The Concrete Properties*.
- Select the concrete to be assigned. This becomes the active assignment. By default, the program will display all elements that share the active assignment in red and the inactive assignment in cyan. Unassigned elements are by default displayed in powder blue. Recall however that you may change the color preferences to your liking with the **Options / Font & Color** command. See *To Change The Font and Color Preference*.
- In the GRAPHICS AREA, using the left-mouse button, marquee select an element or a group of elements (or click a single element). The selected elements are shown in red or in the color specified for ACTIVE OBJECTS in the FONT & COLOR folder. See *To Change The Font and Color Preference*.
- To remove a concrete assignment, repeat the step above using instead, the right mouse button.
- Repeat the three steps above for each concrete entry.

To Assign the Reinforcing Steel Properties:

- From the **Assign** menu select **Reinforcing Steel**, or if the PROPERTIES folder is displayed, click on the  symbol next to REINFORCING STEEL... found in the right ITEM LISTING AREA to expand the REINFORCING STEEL list. The reinforcing steel entries that will appear are those defined using the **Define/Reinforcing Steel** command. See *To Define The Reinforcing Steel Properties*.
- Select the reinforcing steel to be assigned. This becomes the active assignment. By default, the program will display all elements that share the active assignment in red and the inactive assignment in cyan. Unassigned elements are by default displayed in powder blue. Recall however that you may change the color preferences to your liking with the **Options / Font & Color** command. See *To Change The Font and Color Preferences*.
- In the GRAPHICS AREA, using the left-mouse button, marquee select an element or a group of elements (or click a single element). The selected

elements are shown in red or in the color specified for ACTIVE OBJECTS in the FONT & COLOR folder. See *To Change The Font and Color Preference*.

- To remove a reinforcing steel assignment, repeat the step above using instead, the right mouse button.
- Repeat the three steps above for each reinforcing steel entry.

To Assign Design Parameters:

- From the **Assign** menu select **Design Parameters**, or if the PROPERTIES folder is displayed, click on the  symbol next to DESIGN PARAMETERS... found in the right ITEM LISTING AREA to expand the DESIGN PARAMETERS list. The design parameters that will appear are those defined using the **Define / Design Parameters** command. See *To Define The Design Parameters*.
- Select the design parameter entry to be assigned. This becomes the active assignment. By default, the program will display all elements that share the active assignment in red and the inactive assignment in cyan. Unassigned elements are by default displayed in powder blue. Recall however that you may change the color preferences to your liking with the Options / Font & Color command. See *To Change The Font and Color Preferences*.
- In the GRAPHICS AREA, using the left-mouse button, marquee select an element or a group of elements (or click a single element). The selected elements are shown in red or in the color specified for ACTIVE OBJECTS in the FONT & COLOR folder. See *To Change The Font and Color Preference*.
- To remove a design parameter assignment, repeat the step above using instead, the right mouse button.
- Repeat the three steps above for each design parameter entry.

To Assign the Columns:

- From the **Assign** menu select **Column Dimensions**, or if the PROPERTIES folder is displayed, click on the  symbol next to COLUMN DIMENSIONS... found in the right ITEM LISTING AREA to expand the COLUMN DIMENSIONS list.
- Select the column entry to be assigned. This becomes the active assignment. By default, the program will display all nodes that share the active assignment in red and nodes with a different assignment in cyan. Recall however that you may change the color preferences to your liking with the Options / Font & Color command. See *To Change The Font and Color Preferences*.

- In the GRAPHICS AREA, using the left-mouse button, marquee select a node or a group of nodes (or click a single node). The selected nodes are shown in red or in the color specified for ACTIVE OBJECTS in the FONT & COLOR folder. See *To Change The Font and Color Preference*.
- To remove a column assignment, repeat the step above using instead, the right mouse button.
- Repeat the three steps above for each column entry.

Assigning the Restraints

Once the grid, all components, material properties, design parameters, loads and load combinations have been defined, you are ready to start assigning them - thereby putting the project together.

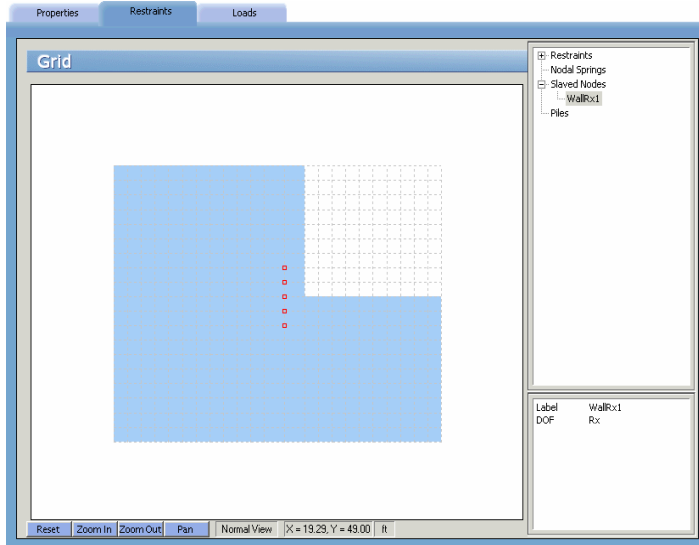

- From the **Assign** menu, choose **Nodal Springs**, **Slaved Nodes** or **Restraints** to have the program surface the RESTRAINTS folder as illustrated above...

Alternatively, you could have clicked on the **Assign** button located on the toolbar, and then on the RESTRAINTS tab.

To Assign Nodal Restraints:

Fixed nodes or supports are assigned using the Assign / Restraints command.

- From the **Assign** menu select **Restraints**, or if the RESTRAINTS is displayed, click on the  symbol next to RESTRAINTS... found in the right ITEM LISTING AREA to expand the RESTRAINTS list. You will be able to restrain D_z , R_x and R_y degrees of freedom.
- Select the nodal restraint to be assigned. This becomes the active assignment. By default, the program will display all nodes that share the active assignment in red and nodes with a different assignment in cyan. Recall however that you may change the color preferences to your liking with the **Options / Font & Color** command. See *To Change The Font and Color Preferences*.
- In the GRAPHICS AREA, using the left-mouse button, marquee select a node or a group of nodes (or click a single node). The selected nodes are shown in red or in the color specified for ACTIVE OBJECTS in the FONT & COLOR folder. See *To Change The Font and Color Preference*.
- To remove a nodal restraint assignment, repeat the step above using instead, the right mouse button.
- Repeat the three steps above for each degree of freedom.

To Assign Nodal Springs:

- From the **Assign** menu select **Nodal Springs**, or if the RESTRAINTS folder is displayed, click on the  symbol next to NODAL SPRINGS... found in the right ITEM LISTING AREA to expand the NODAL SPRINGS list. The nodal springs that appear are those defined using the **Define/Nodal Springs** command. See *To Define The Nodal Springs*.
- Select the nodal spring to be assigned. This becomes the active assignment. By default, the program will display all nodes that share the active assignment in red and nodes with a different assignment in cyan. Recall however that you may change the color preferences to your liking with the **Options / Font & Color** command. See *To Change The Font and Color Preferences*.
- In the GRAPHICS AREA, using the left-mouse button, marquee select a node or a group of nodes (or click a single node). The selected nodes are shown in red or in the color specified for ACTIVE OBJECTS in the FONT & COLOR folder. See *To Change The Font and Color Preference*.

- To remove a nodal spring assignment, repeat the step above using instead, the right mouse button.
- Repeat the three steps above for each nodal spring entry.

To Assign Slaved Nodes:

- From the **Assign** menu select **Slaved Nodes**, or if the RESTRAINTS folder is displayed, click on the  symbol next to SLAVED NODES... found in the right ITEM LISTING AREA to expand the SLAVED NODES list. The slaved node entries that appear are those defined using the **Define / Slaved Nodes** command. See *To Define the Slaved Nodes*.
- Select the slaved node to be assigned. This becomes the active assignment. By default, the program will display all nodes that share the active assignment in red and nodes with a different assignment in cyan. Recall however that you may change the color preferences to your liking with the **Options / Font & Color** command. See *To Change The Font and Color Preferences*.
- In the GRAPHICS area, using the left-mouse button, marquee select a node or a group of nodes (or click a single node). The selected nodes are shown in red or in the color specified for ACTIVE OBJECTS in the FONT & COLOR folder. See *To Change The Font and Color Preference*.
- To remove a slaved node assignment, repeat the step above using instead, the right mouse button.
- Repeat the three steps above for each slaved node entry.

To Assign Piles:

- From the **Assign** menu select **Piles**, or if the RESTRAINTS folder is displayed, click on the  symbol next to PILES... found in the right ITEM LISTING AREA to expand the PILES list. The piles that appear are those previously defined by you. See *To Define the Piles*.
- Select the pile to be assigned. This becomes the active assignment. By default, the program will display all nodes that share the active assignment in red and nodes with a different assignment in cyan. Recall however that you may change the color preferences to your liking with the **Options / Font & Color** command. See *To Change The Font and Color Preferences*.
- In the GRAPHICS AREA, using the left-mouse button, marquee select a node or a group of nodes (or click a single node). The selected nodes are shown in red

or in the color specified for ACTIVE OBJECTS in the FONT & COLOR folder. See To Change The Font and Color Preference.

- To remove a pile assignment, repeat the step above using instead, the right mouse button.
- Repeat the three steps above for each pile in the ITEM LISTING AREA.

Applying the loads

Once the grid, all components, material properties, design parameters, loads and load combinations have been defined, you are ready to start assigning them - thereby putting the project together.

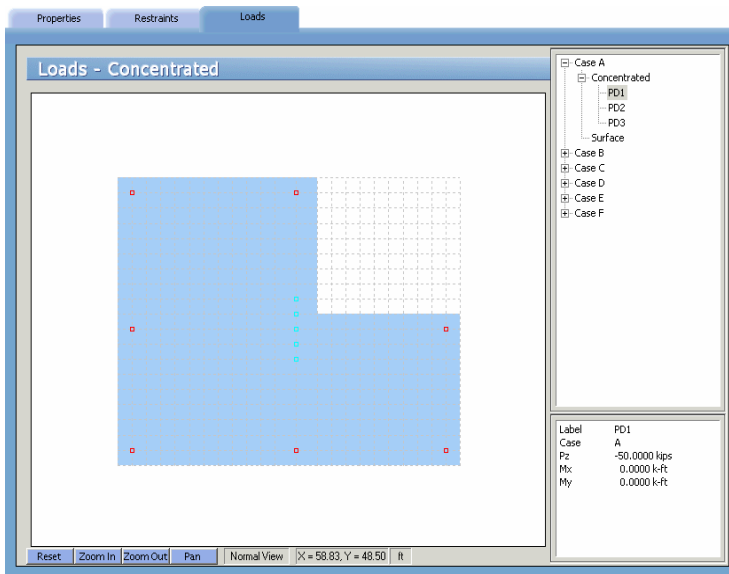

- From the **Assign** menu, choose **Surface Loads** or **Nodal Loads** to have the program surface the LOADS folder as illustrated here...





Alternatively, you could have clicked on the  button located on the toolbar, and then on the LOADS tab.

To Apply Surface Loads:

The surface loads defined using the **Define / Loads** command may be applied to the mat elements using the **Assign / Surface Loads** command. The loads defined under the Dead, Live and Lateral cases are applied under these cases as well.

- From the Assign menu select **Surface Loads**, or if the LOADS folder is displayed, click on the  symbol next to the load CASE... (A through F) found in the right ITEM LISTING AREA to expand the list. The two load types will appear, CONCENTRATED and SURFACE. Expand the Surface load types by clicking on the  symbol next to SURFACE...
- Select the load to be assigned. This becomes the active assignment. By default, the program will display all elements that share the active assignment in red and elements with a different assignment in cyan. Unassigned elements are by default displayed in powder blue. Recall however that you may change the color preferences to your liking with the **Options / Font & Color** command. See *To Change The Font and Color Preferences*.
- In the GRAPHICS AREA, using the left-mouse button, marquee select an element or a group of elements (or click a single element). The selected elements are shown in red or in the color specified for ACTIVE OBJECTS in the FONT & COLOR folder. See *To Change The Font and Color Preference*.
- To remove a surface load assignment, repeat the step above using instead, the right mouse button.
- Repeat the three steps above for each load case.

To Apply Concentrated (Nodal) Loads:

- The concentrated loads defined using the **Define / Loads** command may be applied to the mat elements using the **Assign / Concentrated Loads** command. The loads defined under the Dead, Live and Lateral cases are applied under these cases as well.
- From the **Assign** menu select **Nodal Loads**, or if the LOADS folder is displayed, click on the  symbol next to the load CASE... (A through F) found in the right ITEM LISTING AREA to expand the list. The two load types will appear, CONCENTRATED and SURFACE. Expand the Concentrated load types by clicking on the  symbol next to CONCENTRATED...
- Select the load to be assigned. This becomes the active assignment. By default, the program will display all nodes that share the active assignment in red and

nodes with a different assignment in cyan. Recall however that you may change the color preferences to your liking with the **Options / Font & Color** command. See *To Change The Font and Color Preferences*.

- In the GRAPHICS AREA, using the left-mouse button, marquee select a nodes or a group of nodes (or click on a single node). The selected nodes are shown in red or in the color specified for ACTIVE OBJECTS in the FONT & COLOR folder. See *To Change The Font and Color Preference*.
- To remove a nodal load assignment, repeat the step above using instead, the right mouse button.
- Repeat the three steps above for each load case.

Solving the model

After inputting the model, the solver portion of the program is executed using the **Solve / Execute** command.

From the **Solve** menu, choose **Execute** to have the program surface the SOLVER folder as illustrated here...

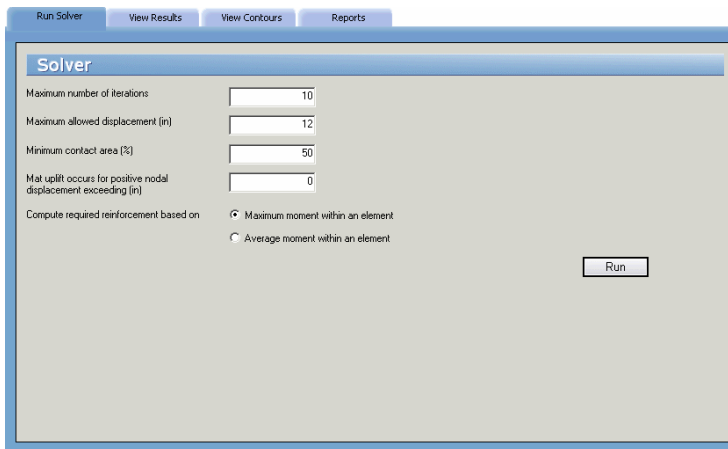

Alternatively, you could have clicked on the **Solve** button located on the toolbar, and then on the RUN SOLVER tab.

- MAXIMUM NUMBER OF ITERATIONS:

If uplift is detected during the solution, the soil contribution at the uplift nodes is eliminated and the problem is resolved. This procedure is repeated until no further uplift is encountered or until the set maximum number of iterations is reached, whichever comes first.

- MAXIMUM ALLOWED DISPLACEMENT:

For any load combination, the deflection at each node is checked versus this value. If it is exceeded, the solution for that combination will not be completed.

- MINIMUM CONTACT AREA:

If uplift is detected during the solution, the tributary area A_u , of all soil-supported nodes in uplift is computed. The program also computes the sum of the tributary areas, A_t , of all non-restrained nodes. The contact area is defined as the ratio $(A_t - A_u)/A_t$. If during the solution, this ratio falls below the specified minimum, the program stops solving for that particular combination.

- MAT UPLIFT OCCURS FOR POSITIVE NODAL DISPLACEMENT EXCEEDING:

This is the value for displacement beyond which a node is considered to be in uplift.

- COMPUTE REQUIRED REINFORCEMENT BASED ON:

For each element, each of the design moments (M_{ux} and M_{uy} , top and bottom) is computed for a governing ultimate load combination. The governing load combination is the one that produces the maximum principal moment (M_{r1} or M_{r2}). Each element has four values of M_{ux} and M_{uy} (one at each node). The required area of reinforcement for an element may be computed based on:

- MAXIMUM MOMENT WITHIN AN ELEMENT (the maximum moment at any of the four element nodes.)
- AVERAGE MOMENT WITHIN AN ELEMENT (the average moment value at all element nodes.)
- The input is first verified for any inconsistencies or errors. If there is data missing or still required, a message box will be displayed.
- The program then switches control to the solve module. A message box reporting the progress and status of the solution is displayed.

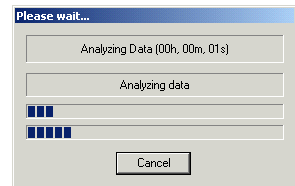

- When the solution is successfully completed, a contour map showing downward displacement envelope is displayed. If the solution procedure fails, a message box appears. Detailed information on the solution may be found in the **Solve / View Results / Solve Messages** window.
- After a successful run, results may be viewed using the **Solve / View Results** command. The results can be printed using the **File / Print Results** command. Results may also be plotted using the **Solve / View Contours** command.

Viewing the Results

After a successful run, the output may be viewed using the **Solve / View Results** command.

- From the **Solve** menu, choose **View Results** to have the program surface the VIEW RESULTS folder as illustrated here...

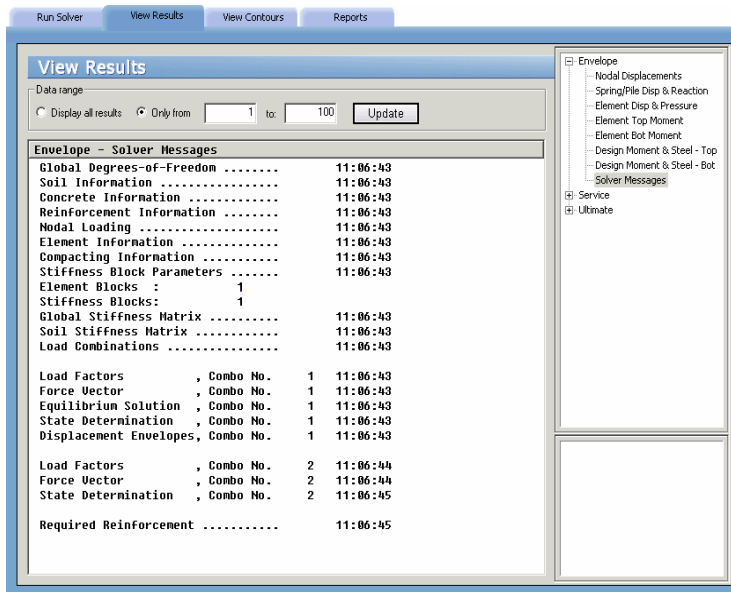

Alternatively, you could have clicked on the **Solve** button located on the toolbar, and then on the VIEW RESULTS tab.

- The results are categorized into three types:
 - Envelope

- Service
- Ultimate
- Expand the type you wish to view by clicking on the  symbol next to the type (ENVELOPE, SERVICE, or ULTIMATE) found in the right ITEM LISTING AREA.
- If Service or Ultimate is selected, a combination must be selected from the expandable list. For more information on the output tables, see *Program Results* in Chapter 2.
- Choose the result table to display from the available items in the right ITEM LISTING AREA.
- The requested information is shown in the GRAPHICS / INPUT AREA. Use the scroll bars to navigate through the results. To print the displayed results, choose the **File / Print Results** command.

Viewing the Contours

After a successful run, the output may be graphically viewed using the **Solve / View Contours** command.

- From the Solve menu, choose **View Contours** to have the program surface button located on the toolbar,

Alternatively, you could have clicked on the  button located on the toolbar, and then on the VIEW CONTOURS tab.

- The results are categorized into three types:
 - Envelope
 - Service
 - Ultimate
- Once the VIEW CONTOURS folder surfaces, expand the type you wish to view by clicking on the  symbol next to the type (ENVELOPE, SERVICE, or ULTIMATE) found in the right ITEM LISTING AREA.
- Locate the results you wish to view graphically by expanding to the root.
- The requested contours are shown in the GRAPHICS/INPUT AREA. Note that top and bottom moments are plotted separately.

- To print the displayed contours, choose the **File / Print Screen** command.

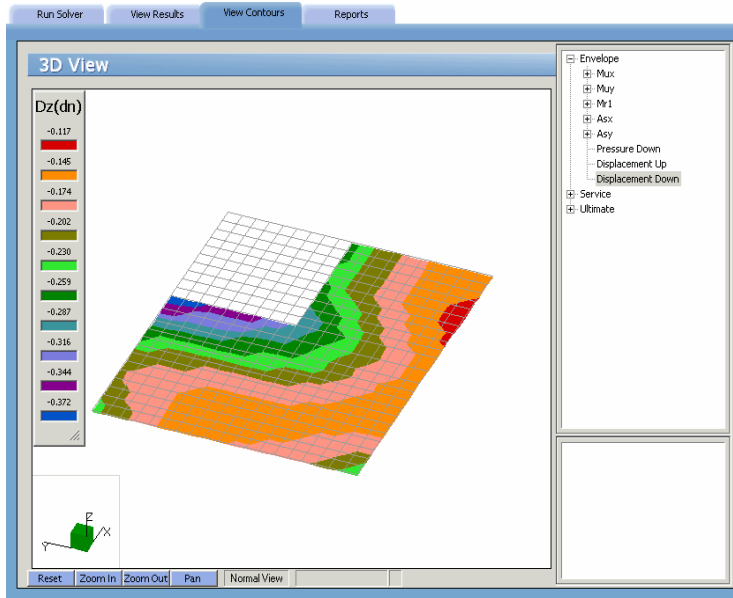

Accessing the 3D View

The 3D view provides a three dimensional graphic representation of the slab. This screen allows you to rotate the slab, zoom in, zoom out and pan.

- From the **View** menu, choose **3D** to have the program surface the 3D VIEW folder.

Alternatively, you could have clicked on the **Project** button located on the toolbar, and then on the 3D VIEW tab.

Using the Zoom Command:

The **Zoom** command is used to enlarge or reduce the image shown in the 3D VIEW folder in the GRAPHICS / INPUT AREA. This command is only used for display purposes and does not affect the model geometry.

To Zoom In:

- With the 3D VIEW folder displayed, click on the **Zoom In** button found at the bottom of the GRAPHICS / INPUT AREA.

- Using the left-mouse button, marquee select the portion of the graphical image you wish to enlarge. The selected area is enlarged to occupy the entire GRAPHICS / INPUT area.

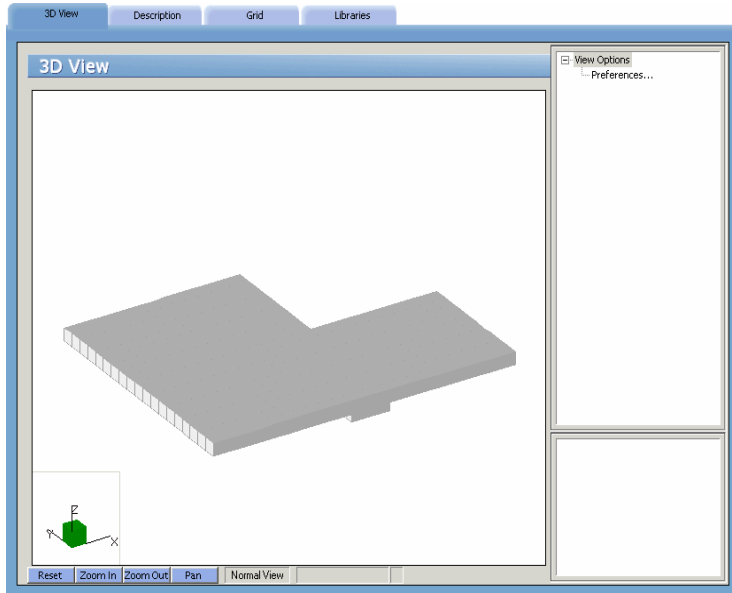

To Zoom Out:

- With the 3D VIEW displayed, click on the **Zoom Out** button found at the bottom of the GRAPHICS / INPUT AREA.
- Using the left-mouse button, marquee select the portion of the graphical image you wish to reduce. The selected area is proportionally readjusted in the GRAPHICS / INPUT area.

Using the Pan Command:

The **Pan** command is used to move the image shown in the 3D VIEW folder in the GRAPHICS / INPUT area. Image panning or translation is a linear movement of the viewport. This command is only used for display purposes and does not affect the model geometry.

- With the 3D VIEW folder displayed, click on the **Pan** button found at the bottom of the GRAPHICS / INPUT area.

- Click and hold the left-mouse button on the graphic while dragging it around the GRAPHICS / INPUT area. The image is anchored (moved) when the left-mouse button is released.

Using the Reset Command:

The Reset command is used to reset the image shown in the 3D VIEW folder in the GRAPHICS / INPUT AREA to its default position.

- With the 3D VIEW folder displayed, click on the  button found at the bottom of the GRAPHICS / INPUT area.

Alternatively, you could simply right-button click anywhere within the GRAPHICS / INPUT area.

Using the Rotate Command:

The Rotate command is used (in isometric 3D only) to rotate the image shown in the 3D VIEW folder so that the model may be viewed from a different viewpoint. This command works with the axis-orientation box located at the bottom of the GRAPHICS / INPUT area...

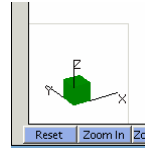

This command is only used for display purposes and does not affect the model geometry.

- With the 3D VIEW folder displayed, click and hold down the left mouse button on the axis-orientation box.
- Drag the mouse in any direction while holding down the left-mouse button. Notice the corresponding rotations of both the axis bar as well as the graphic. The axis orientation represents the position of the model as soon as the left-mouse button is released.

Defining the Options

There are many options that can be set as default so that they are saved in memory to be applied to any subsequent project until they are changed again.

From the **Options** menu, choose **Startup Defaults**, **Autosave**, **Font & Color** or **Statistics** to have the program surface the respective OPTION folder as illustrated.

Alternatively, you could have clicked on the  button located on the toolbar.

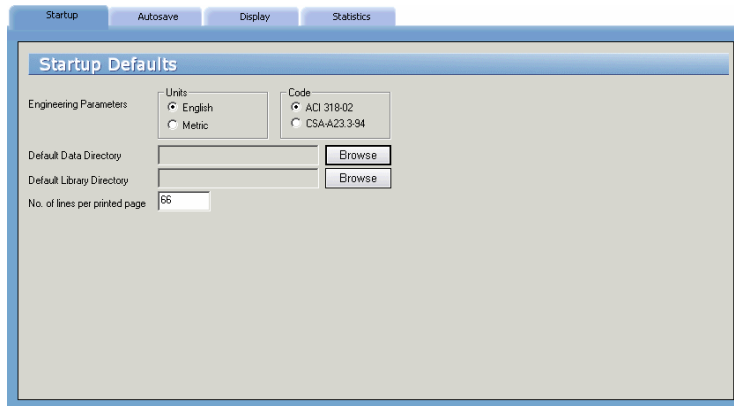

To Define the Startup Defaults:

The **Options / Startup Defaults** command is used to save the current file settings to be used in future input sessions. Default settings are saved in the PCAPROGS.INI file located in the WINDOWS directory. Settings that are saved include units of measure, code, and default directories.

- With the STARTUP folder surfaced, from the UNITS options group, choose the applicable units of measure and from the CODE options group, select the appropriate design code.
- Specify a default data directory. The path you specify here is where any data files you save will be saved by default. Note, however, that you will still be able to specify a different location when you attempt to save. See *Saving the Data*.
- You may also specify the location of your text viewer (i.e. MS Notepad) and you may control the number of lines printed per page.

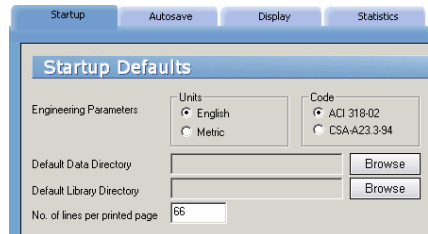

To Control the Autosave feature:

The **Options / Autosave** command is used to force the program to save your input data to disk at predefined intervals. This minimizes loss of data in case of a power loss or computer lock-up. Note that the file must be named (using the **File / Save As** command) prior to activating this feature.

- With the AUTOSAVE folder surfaced, place a checkmark in the ENABLE AUTOSAVE box to activate the auto save feature.
- In the Frequency text box, specify the time interval that you would like the program to run the autosave feature.

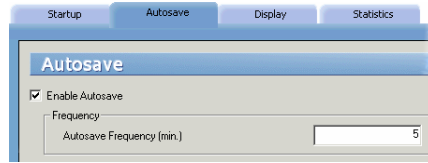

To Customize the Font and Color:

The **Options / Font & Color** command is used to change the color settings of the graphical image to those of personal preference.

- With the FONT & COLOR folder surfaced, click on the CHOOSE FONT button to select the font type and size that will be used in plotting the node and element numbers on the graphical display. The font types that appear in the list are those saved in your WINDOWS/FONTS directory. The font you specify here is also used in screen-printing.
- Use the color drop-down lists within the OBJECT COLOR group to select preferred colors for the following...
 - Grid
 - Active (object, node or element)
 - Inactive (object, node or element)
 - Frame
 - Background

To View the Project Statistics:

- Surface the STATISTICS folder by using the **Options / Statistics** command...

Alternatively, you could have clicked on the **Options** button located on the toolbar, and then on the STATISTICS tab.

- The folder displays a statistical summary on the number of nodes, elements and definitions.

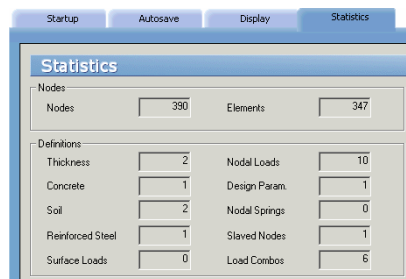

Chapter 5

Examples

Helpful Hints

1. Many of the procedures in this chapter require that you marquee select the region $(x1, y1) - (x2, y2)$.

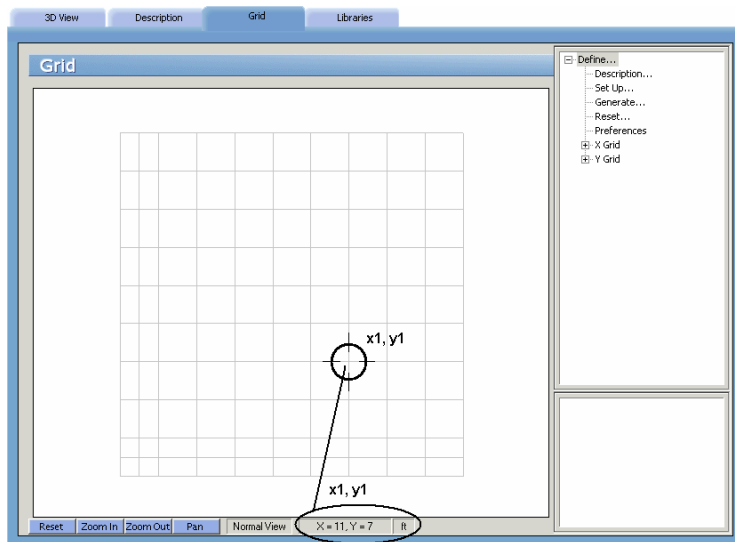

To marquee select:

- Place the cursor at the location $(x1, y1)$. Notice how the coordinates change in the lower part of the screen as you move the mouse cursor.
- Click and hold down the left-mouse button.
- While holding the mouse button down, drag to the second location $(x2, y2)$. A dashed rectangle will appear as you drag the cursor.
- Release the mouse button.

2. Both examples make use of the following color settings (chosen from the **Options Menu / Font & Color** command):
3. It may also be helpful to set the GRID LINE type to Dot, the COORDINATE PRECISION to 0.1, and the 3D FACTOR to 1.

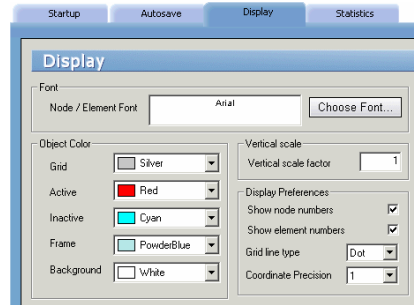

Example 1

The 10' x 10' x 2' footing is presented in Joseph F. Bowles' *Foundation Analysis and Design*, Fourth Edition, 1988, p.461.

A 500-kip load is applied at the center of the footing.

Use the following data:

concrete: $f'_c = 3.0$ ksi,

$w_c = 148$ pcf,

$E_c = 3,254$ ksi,

$\nu = 0.15$,

soil: subgrade modulus = 100 kcf,

allowable pressure = 6 ksf,

steel: $f_y = 60$ ksi,

$E_s = 29,000$ ksi.

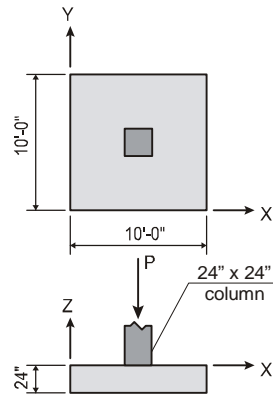

The origin of the XY plane will be located at the lower left-hand corner of the footing. Two-foot square elements will be used; thus, the grid system consists of six grid lines (i.e. five elements), two feet apart, in each direction. The concentrated load will be applied as four nodal loads (125 kip each). The finite element mesh is shown at the end of this example.

Inputting Problem Databases

1. From the **Define** menu, select **General Info** to surface the DESCRIPTION folder...

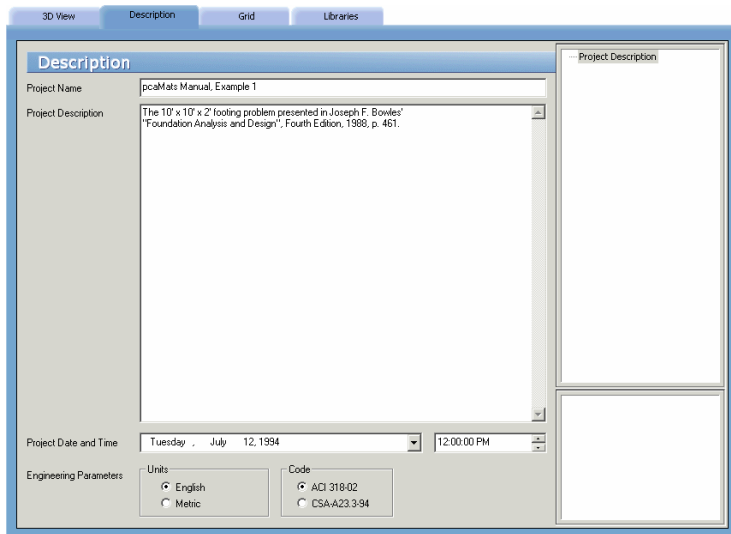

- Input the project information and select ENGLISH units along with the ACI code. Notice how the current date and time is displayed by default.
2. From the **Define** menu, select **Grid**, or simply click on the **Grid** tab to surface the respective folder...

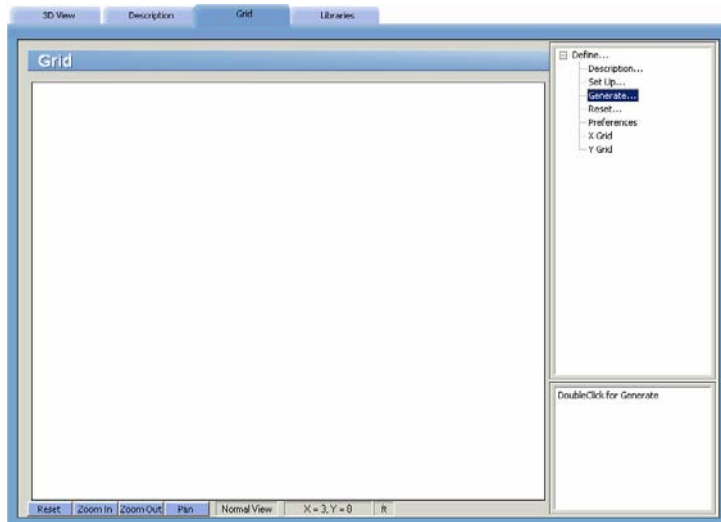

Since the grid layout is uniform, and symmetrical in both directions, X and Y grid lines will be generated.

- Double-click on the GENERATE option in the ITEM LISTING AREA to have the program surface the following...

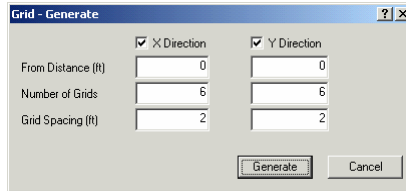

- Place a check mark in the X- DIRECTION box and enter the following values in the corresponding text boxes...

FROM DISTANCE:	0
NUMBER OF GRIDS:	6
GRID SPACING:	2

- Repeat the above step for the Y-DIRECTION.
- Click on the GENERATE button to return focus to the GRID folder. Notice how the X and Y grid lines now appear in the GRAPHICS/INPUT AREA.

3. From the **Define** menu, choose **Thickness** to surface the PROPERTIES folder...

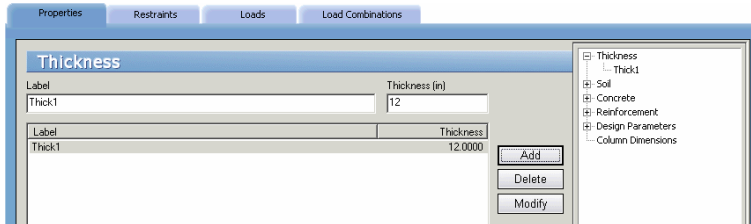

- Input Thick1 for LABEL and 24.0 for THICKNESS.
- Click on the ADD button to add the entry to the list.

4. From the **Define** menu, choose **Soil**,

- Enter the following...

LABEL:	Soil1
SUBGRADE MODULUS:	100 kcf

ALLOWABLE PRESSURE: 6 ksf

- Click on the ADD button to add the entry to the list.

5. From the **Define** menu, choose **Concrete** or click on the CONCRETE option in the ITEM LISTING AREA to have the program surface the respective folder.

- Enter the following...

LABEL: Conc1
 COMPRESSIVE STRENGTH: 3 ksi
 UNIT WEIGHT: 148 pcf
 YOUNG'S MODULUS: 3245 ksi
 POISSON'S RATIO: 0.15

- Click on the ADD button to add the entry to the list.

6. From the **Define** menu, choose **Reinforcing Steel** or click on the REINFORCEMENT option in the ITEM LISTING AREA to have the program surface the respective folder.

- Enter the following...

LABEL: Steel1
 YIELD STRENGTH: 60 ksi
 YOUNG'S MODULUS: 29000 ksi

- Click on the ADD button to add the entry to the list.

7. From the **Define** menu, choose **Design Parameters** or click on the DESIGN PARAMETERS option in the ITEM LISTING AREA to have the program surface the respective folder.

- Enter the following...

LABEL: DC1
 MIN. REINF. RATIO: 0.18 %
 X-DIR (TOP): 3.25 in
 (BOTTOM): 3.25 in
 Y-DIR (TOP): 3.75 in
 (BOTTOM): 3.75 in

- Click on the ADD button to add the entry to the list.

8. From the **Define** menu, select **Loads**, or simply click on the **Loads** tab to surface the respective folder...

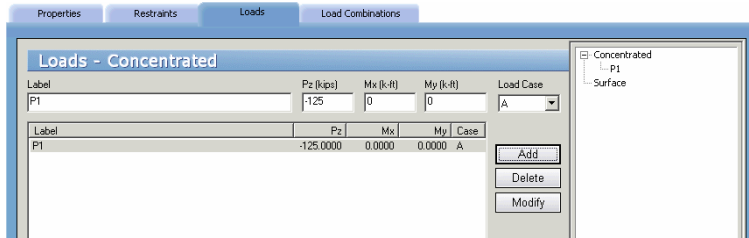

- Select CONCENTRATED from the ITEM LISTING AREA and enter P1 for LABEL.
 - Select A from the LOAD CASE drop-down list and enter -125 for Pz.
 - Click on the ADD button to add the entry to the list.
9. From the **Define** menu, choose **Load Combinations**, or simply click on the **Load Combinations** tab to surface the respective folder...

- From the LEVEL drop-down list, select SERVICE.
- Enter S1 for LABEL
- Enter 1.0 for CASE A and 0.0 for all other cases.
- Check the SAVE RESULTS box and click on the ADD button to add the entry to the list.
- From the LEVEL drop-down list, select ULTIMATE.
- Enter U1 for LABEL
- Enter 1.0 for CASE A and 0.0 for all other cases.
- Check the SAVE RESULTS box and click on the ADD button to add the entry to the list.

- Click on the OPTIONS button to surface the following...
- Clear the Include SELF WEIGHT IN CASE A option and click on the OK button to return focus to the LOAD COMBINATIONS folder.

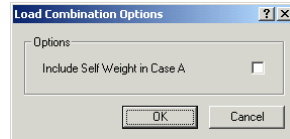

Assigning Properties

10. From the **Assign** menu, select **Thickness** to surface the respective folder.
 - From the ITEM LISTING AREA, select THICK1.
 - In the GRAPHICS/INPUT AREA, marquee-select the region (-1, 11)-(11, -1) to apply the selected thickness to the entire footing. The selected elements are redrawn in red.

Note: To see the assigned element and node numbers, from the **Define** menu, select Grid, and once the GRID folder surfaces, double click on PREFERENCES.
11. From the **Assign** menu, select **Soil** or click on the SOIL option in the ITEM LISTING AREA.
 - Expand the SOIL listing in the ITEM LISTING AREA and select SOIL1.
 - In the GRAPHICS/INPUT AREA, marquee-select the region (-1, 11)-(11, -1) to apply the selected soil to the entire footing. The selected elements are redrawn in red.
12. Repeat the step above using the **Assign / Concrete**, **Assign / Reinforcing Steel** and **Assign / Design Parameters** commands to apply CONCRETE1, STEEL1 and DC1 properties to the entire footing.
13. From the **Assign** menu, select **Nodal Loads** or simply click on the  tab to surface the respective folder.
 - In the ITEM LISTING AREA, expand Case A and then expand Concentrated to select P1.
 - In the GRAPHICS AREA, click on each of the four nodes (4, 4), (6, 4), (4, 6) and (6,6). Small red squares are shown indicating loaded nodes...

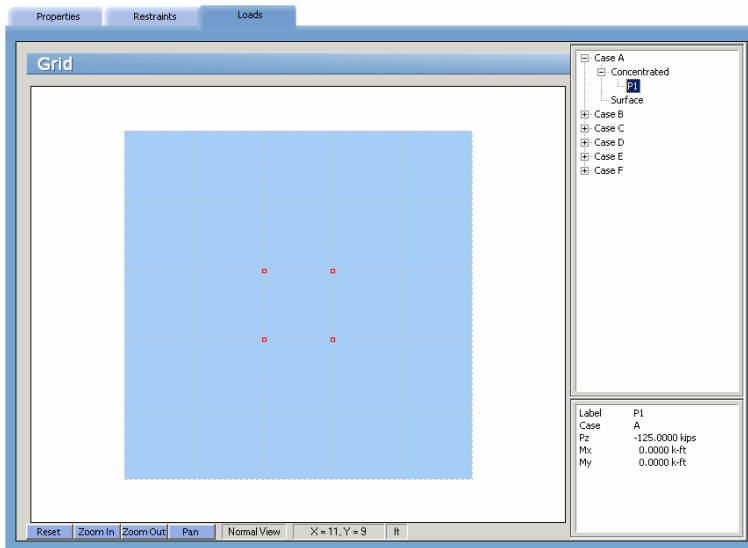

Solving

14. From the **Solve** menu, select **Execute** to surface the SOLVER folder...

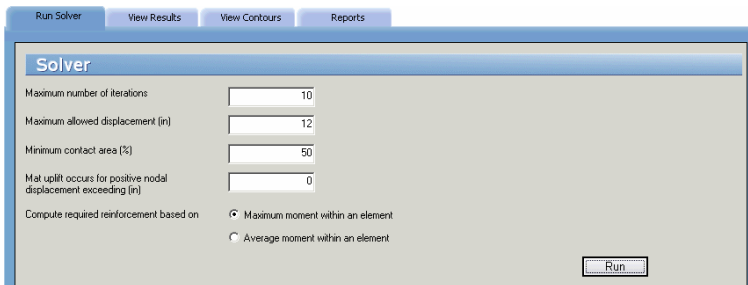

- Enter 10, 12, 50 and 0 in the text boxes and choose the Maximum moment within an element option.
- Click on the Run button.
- The pcamats Solver window is displayed and the solver messages are listed. After the solution is done focus will immediately be passed to the View Results folder.

Viewing and Printing Results

15. To view the results in text format, use the **Solve / View Results** command. Selective printing may be done from the displayed box or using the **File / Print Results** command.
16. To view the results in graphical format, use the **Solve / View Contours** command. A printout of the screen may be obtained using the **File / Print Screen** command.

The screenshot shows the 'View Results' window with the following data table:

Envelope - Design Moment & Steel - Bot											
CSb - ELEMENT BOTTOM DESIGN MOMENT AND REINFORCEMENT:											
Units --> Moment (kip-ft/ft), As (in ² /ft)											
Elem	Node	Ld	Comb.	Max. H(ux)	As(ux)	Node	Ld	Comb.	Max. H(uy)	As(uy)	
1	8	U1		-16.81	0.450	8	U1		-16.81	0.480	
2	9	U1		-36.95	1.066	8	U1		-18.27	0.525	
3	9	U1		-35.28	1.010	9	U1		-9.17	0.259m	
4	10	U1		-36.95	1.066	11	U1		-18.27	0.525	
5	11	U1		-16.81	0.450	11	U1		-16.81	0.480	
6	8	U1		-18.27	0.491	14	U1		-36.95	1.154	
7	15	U1		-54.91	--	x	15	U1	-54.91	--	x
8	15	U1		-56.24	--	x	15	U1	-57.43	--	x
9	16	U1		-54.91	--	x	16	U1	-54.91	--	x
10	11	U1		-18.27	0.491	17	U1		-36.95	1.154	
11	14	U1		-9.17	0.259m	20	U1		-35.28	1.092	
12	15	U1		-57.43	--	x	15	U1	-56.24	--	x
13	15	U1		-50.83	1.565	15	U1		-50.83	--	x
14	16	U1		-57.43	--	x	16	U1	-56.24	--	x
15	17	U1		-9.17	0.259m	23	U1		-35.28	1.092	
16	26	U1		-18.27	0.491	20	U1		-36.95	1.154	
17	21	U1		-54.91	--	x	21	U1	-54.91	--	x
18	21	U1		-56.24	--	x	21	U1	-57.43	--	x
19	22	U1		-54.91	--	x	22	U1	-54.91	--	x
20	29	U1		-18.27	0.491	23	U1		-36.95	1.154	

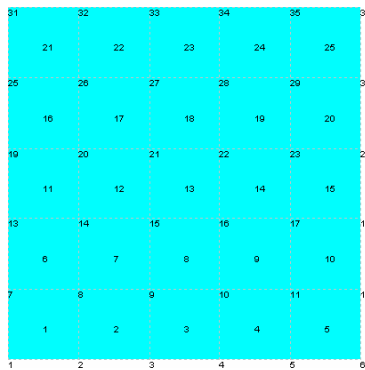

Element and Node Numbering for Example 1

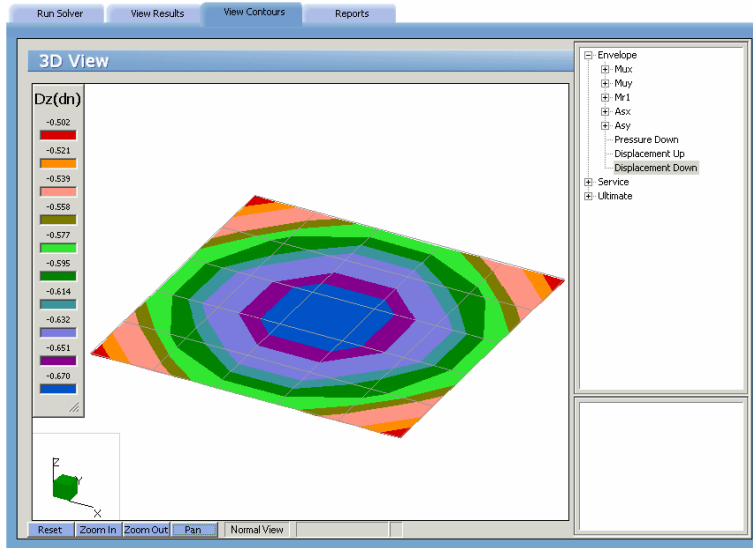

Displacement contours for Example 1

Example 2

Analyze the mat shown...

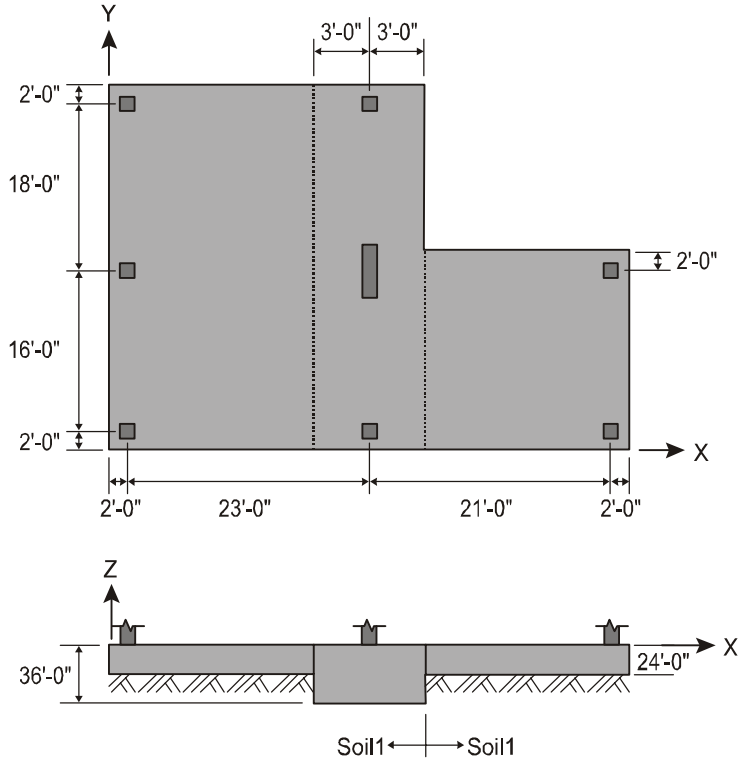

The mat is supported on two types of soil, soil-1 and soil-2, as shown in the figure. Use the following data:

concrete: $f'_c = 3.0$ ksi,

$w_c = 145$ pcf,

$E_c = 3,156$ ksi,

$\nu = 0.15$,

soil-1: subgrade modulus = 50 kcf,

allowable pressure = 6 ksf,
 soil-2: subgrade modulus = 75 kcf,
 allowable pressure = 8 ksf,
 steel: $f_y = 60$ ksi,
 $E_s = 29,000$ ksi.

The superstructure was analyzed for wind loads. The resulting reactions for the columns and wall, as well as the dead and live loads, are as follows:

		Dead	Live	Wind
Column	P_z (kip)	-50	-35	-10
	M_x (ft-kip)	0	0	5
	M_y (ft-kip)	0	0	0
Wall	P_z (kip)	-376	-208	-80
	M_x (ft-kip)	0	0	60
	M_y (ft-kip)	0	0	0

The mat will be analyzed for three service combinations and three ultimate combinations. Deflections and pressures are to be checked for the service combinations and the mat will be designed (compute required reinforcement) for the ultimate combinations.

Service Combinations: $S1 = D+L$
 $S2 = D + L + W$
 $S3 = D + W$

Ultimate Combinations: $U1 = 1.4 D$
 $U2 = 1.2 D + 1.6 L$
 $U3 = 1.2 D + 1.0 L$
 $U4 = 1.2 D + 0.8 W$
 $U5 = 1.2 D + 1.0 L + 1.6 W$
 $U6 = 0.9 D + 1.6 W$
 $U7 = 1.2 D - 0.8 W$
 $U8 = 1.2 D + 1.0 L - 1.6 W$
 $U9 = 0.9 D - 1.6 W$

The lower left-hand corner of the mat is chosen as the origin of the grid system. The grid layout is shown at the end of this example.

Since the wall is spanning over five nodes (nodes 205, 229, 253, 277 and 291), the wall loads will be divided into equivalent nodal loads depending on the tributary length of each node. Furthermore, the R_x degrees of freedom of these five nodes are slaved to simulate the stiffening effect of the wall.

Wall Loading Conditions

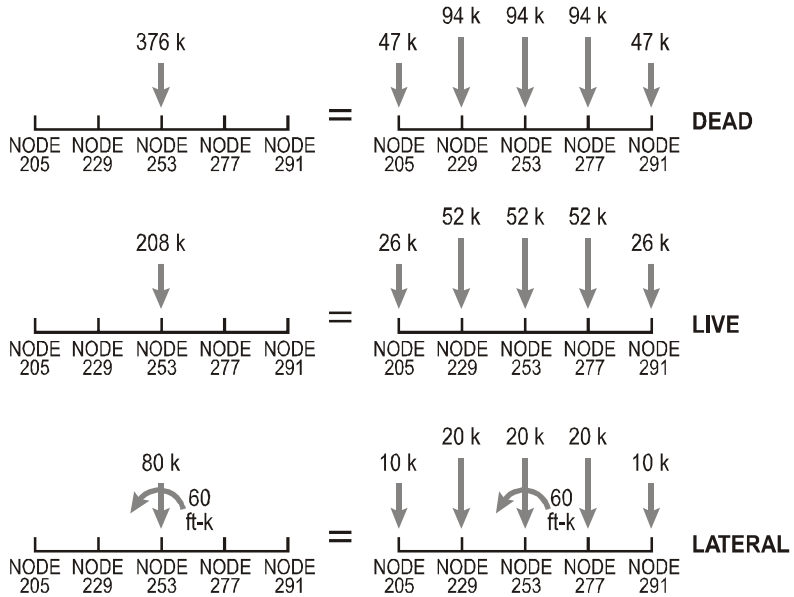

Inputting Problem Databases

1. From the **Define** menu, select **General Info** to surface the DESCRIPTION folder...

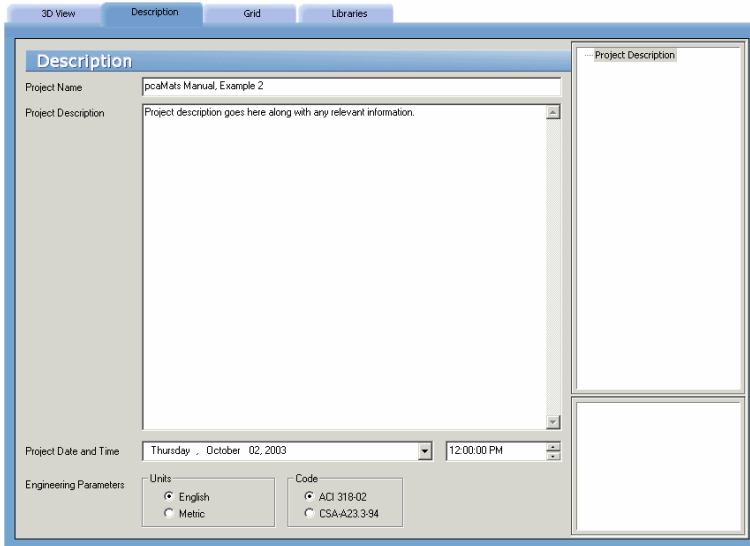

- Input the project information and select ENGLISH units along with the ACI code. Notice how the current date and time is displayed by default.
2. From the **Define** menu, select **Grid**, or simply click on the tab to surface the respective folder.

The X-Grid will be created in three parts as per the illustration below...

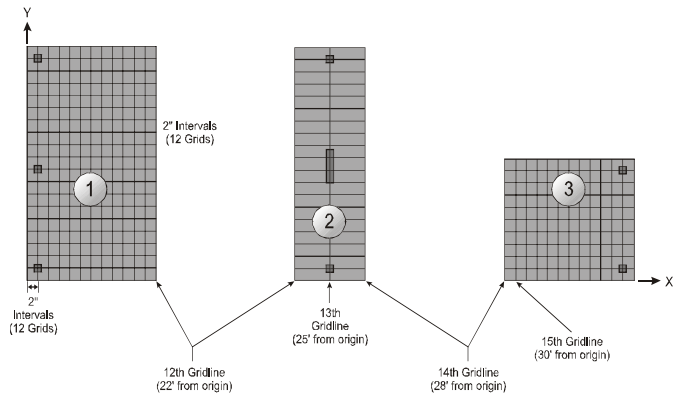
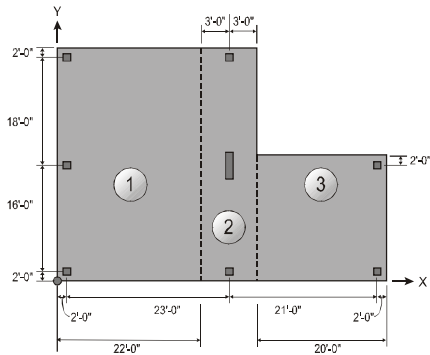

- Double-click on the GENERATE option in the ITEM LISTING AREA to have the program surface the GENERATE dialog box.

- Place a check mark in the X-Direction box and enter the following values in the corresponding text boxes...

FROM DISTANCE:	0
NUMBER OF GRIDS:	12
GRID SPACING:	2

- Place a check mark in the Y-Direction box and enter the following values in the corresponding text boxes...

FROM DISTANCE:	0
NUMBER OF GRIDS:	20
GRID SPACING:	2

- Click on the GENERATE button to return focus to the GRID folder. Notice how the X and Y grid lines now appear in the GRAPHICS/INPUT AREA. Note that you have just generated the Y-Grid lines for the entire slab and the X-grid lines have only been generated for section 1 as per the illustration above.

- To create the two grid lines in section 2, double-click on the SET UP option in the ITEM LISTING AREA to have the program surface the following dialog box...
- With the X-DIRECTION option chosen input 25 in the COORDINATE text box and click on ADD.
- Input 28 in the COORDINATE text box and click on ADD.

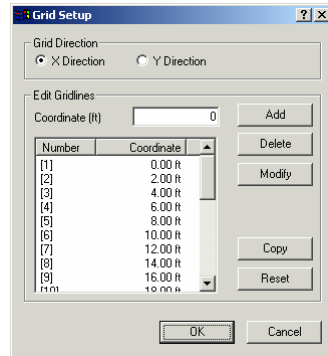

- Click on OK to return focus to the GRID folder. Note how the two grid lines just added now appear in the GRAPHICS/INPUT AREA.
- To create the remaining grid lines in the third section, double-click on the GENERATE option in the Item Listing Area to have the program surface the GENERATE dialog box, shown here for illustrative purposes...

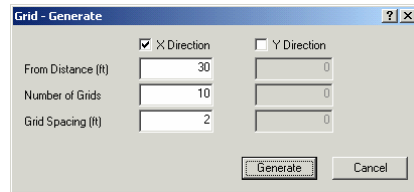

- Place a check mark in the X-DIRECTION box and enter the following values in the corresponding text boxes...

FROM DISTANCE:	30
NUMBER OF GRIDS:	10
GRID SPACING:	2
- Click on the GENERATE button to return focus to the GRID folder. Notice how the 10 new X grid lines now appear in the GRAPHICS/INPUT AREA.

3. From the **Define** menu, choose **Thickness** to surface the PROPERTIES folder...

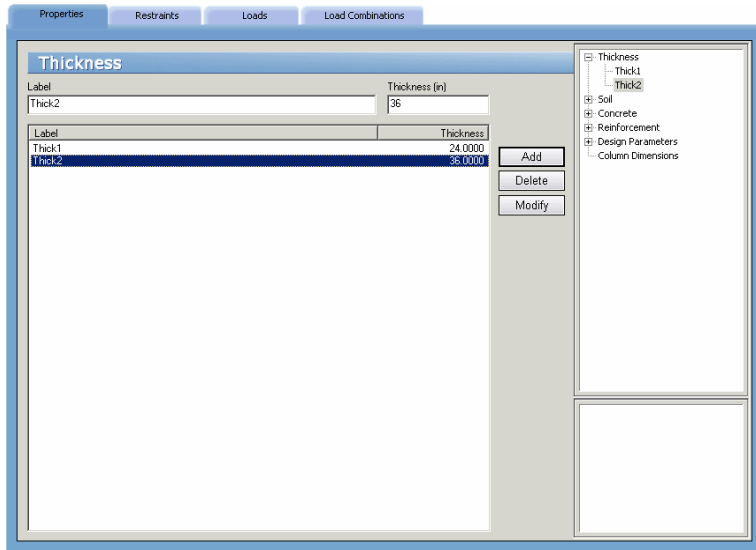

- Input Thick1 for LABEL and 24.0 for THICKNESS.
 - .Click on the ADD button to add the entry to the list.
 - Input Thick21 for LABEL and 36.0 for THICKNESS.
 - Click on the ADD button to add the entry to the list.
4. From the **Define** menu, choose **Soil**, or click on the SOIL option in the ITEM LISTING AREA to have the program surface the respective folder.
- Enter the following...

LABEL:	Soil1
SUBGRADE MODULUS:	50 kcf
ALLOWABLE PRESSURE:	6 ksf
 - Click on the ADD button to add the entry to the list.
 - Enter the following...

LABEL:	Soil2
SUBGRADE MODULUS:	75 kcf
ALLOWABLE PRESSURE:	8 ksf
 - Click on the ADD button to add the entry to the list.

5. From the **Define** menu, choose **Concrete** or click on the CONCRETE option in the ITEM LISTING AREA to have the program surface the respective folder.
 - Enter the following... LABEL: Concl

COMPRESSIVE STRENGTH:	3 ksi
UNIT WEIGHT:	145 pcf
YOUNG'S MODULUS:	3156 ksi
POISSON'S RATIO:	0.15
 - Click on the ADD button to add the entry to the list.

6. From the **Define** menu, choose **Reinforcing Steel** or click on the REINFORCEMENT option in the ITEM LISTING AREA to have the program surface the respective folder.
 - Enter the following...

LABEL:	Steel1
YIELD STRENGTH:	60 ksi
YOUNG'S MODULUS:	29000 ksi
 - Click on the ADD button to add the entry to the list.

7. From the **Define** menu, choose **Design Parameters** or click on the DESIGN PARAMETERS option in the ITEM LISTING AREA to have the -program surface the respective folder.
 - Enter the following...

LABEL:	DC1
MIN. REINF. RATIO:	0.18 %
X-DIR (TOP):	3.25 in
(BOTTOM):	3.25 in
Y-DIR (TOP):	3.50 in
(BOTTOM):	3.50 in
 - Click on the ADD button to add the entry to the list.

8. From the **Define** menu, select **Slaved Nodes**, or simply click on the tab and then select the SLAVED NODES option in the ITEM LISTING AREA to surface the respective folder...
 - Enter Wall Rx1 in the LABEL text boxes.

- Select Rx from the DEGREE OF FREEDOM group.
 - Click on the ADD button to add the entry to the list.
9. From the **Define** menu, select **Loads**, or simply click on the tab to surface the respective folder...

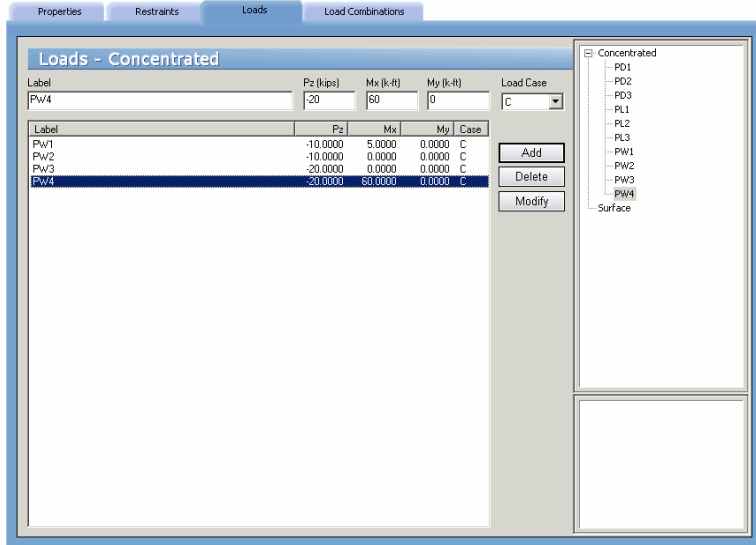

- Select CONCENTRATED from the Item Listing Area and enter PD1 for LABEL.
- Select A from the LOAD CASE drop-down list and enter the following...
 $Pz = -50$ kips
 $Mx = 0$ k-ft
 $My = 0$ k-ft
- Click on the ADD button to add the entry to the list.
- Repeat the 3 steps above to enter the remaining two dead loads shown in the table below (PD2 and PD3).

Case	Label	Pz	Mx	My
A	PD1	-50	0	0
	PD2	-47	0	0
	PD3	-94	0	0

- Select CONCENTRATED from the Item Listing Area and enter PL1 for LABEL.
- Select B from the LOAD CASE drop-down list and enter the following...
 $P_z = -35$ kips
 $M_x = 0$ k-ft
 $M_y = 0$ k-ft
- Click on the ADD button to add the entry to the list.
- Repeat the 3 steps above to enter the remaining two live loads shown in the table below (PL2 and PL3)

Case	Label	Pz	Mx	My
B	PL1	-35	0	0
	PL2	-26	0	0
	PL3	-52	0	0

- Select CONCENTRATED from the Item Listing Area and enter PW1 for LABEL.
- Select C from the LOAD CASE drop-down list and enter the following...
 $P_z = -10$ kips
 $M_x = 5$ k-ft
 $M_y = 0$ k-ft
- Click on the ADD button to add the entry to the list.
- Repeat the 3 steps above to enter the remaining three wind loads shown in the table below (PW2, PW3 and PW4).

Case	Label	Pz	Mx	My
C	PW1	-10	5	0
	PW2	-10	0	0
	PW3	-20	0	0
	PW4	-20	60	0

10. From the **Define** menu, choose **Load Combinations**, or simply click on the tab to surface the respective folder...
 - From the LEVEL drop-down list, select SERVICE.
 - Enter S1 for LABEL
 - Enter 1.0 for CASE A and CASE B and 0.0 for all other cases.
 - Check the SAVE RESULTS box and click on the ADD button to add the entry to the list.
 - Enter S2 for LABEL
 - Enter 1.0 for case A, Case B and Case C and 0.0 for cases D, E and F.
 - Check the SAVE RESULTS box and click on the ADD button to add the entry to the list.
 - Enter S3 for LABEL and 1.0 for Case A and Case C. Enter 0.0 for all other cases.
 - Check the SAVE RESULTS box and click on the ADD button to add the entry to the list.
 - From the LEVEL drop-down list, select ULTIMATE and enter U1 for LABEL.
 - Enter 1.4 for CASE A, and 0.0 for all other cases.
 - Check the SAVE RESULTS box and click on the ADD button to add the entry to the list.
 - Enter U2 for LABEL and 1.2 for CASE A, 1.6 for CASE B, and 0.0 for all other cases.

-
- Check the SAVE RESULTS box and click on the ADD button to add the entry to the list.
 - Enter U3 for LABEL
 - Enter 1.2 for CASE A, 1.0 for CASE B, and 0.0 for all other cases.
 - Check the SAVE RESULTS box and click on the ADD button to add the entry to the list.
 - Enter U4 for LABEL
 - Enter 1.2 for CASE A, 0.8 for CASE C, and 0.0 for all other cases.
 - Check the SAVE RESULTS box and click on the ADD button to add the entry to the list.
 - Enter U5 for LABEL
 - Enter 1.2 for CASE A, 1.0 for CASE B, 1.6 for CASE C and 0.0 for all other cases.
 - Check the SAVE RESULTS box and click on the ADD button to add the entry to the list.
 - Enter U6 for LABEL
 - Enter 0.9 for CASE A, 1.6 for CASE C, and 0.0 for all other cases.
 - Check the SAVE RESULTS box and click on the ADD button to add the entry to the list.
 - Enter U7 for LABEL
 - Enter 1.2 for CASE A, -0.8 for CASE C, and 0.0 for all other cases.
 - Check the SAVE RESULTS box and click on the ADD button to add the entry to the list.
 - Enter U8 for LABEL
 - Enter 1.2 for CASE A, 1.0 for CASE B, -1.6 for CASE C, and 0.0 for all other cases.
 - Check the SAVE RESULTS box and click on the ADD button to add the entry to the list.
 - Enter U9 for LABEL

- Enter 0.9 for CASE A, -1.6 for CASE C, and 0.0 for all other cases.
- Check the SAVE RESULTS box and click on the ADD button to add the entry to the list.
- Click on the OPTIONS button to surface the following...
- Clear the Include SELF WEIGHT IN CASE A option and click on the OK button to return focus to the LOAD COMBINATIONS folder.

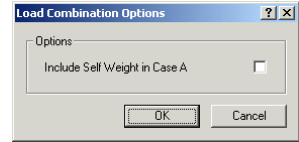

Assigning Properties

- From the **Assign** menu, select **Thickness** to surface the respective folder.
 - From the ITEM LISTING AREA, select THICK1.
 - In the GRAPHICS/INPUT AREA, marquee-select the region (-1,39) – (23, -1) to apply the selected thickness to that part of the footing.
 - Marquee-select the region (27,21) – (49, -1) to apply the selected thickness to that part of the footing. Notice how the selected regions are redrawn in red...

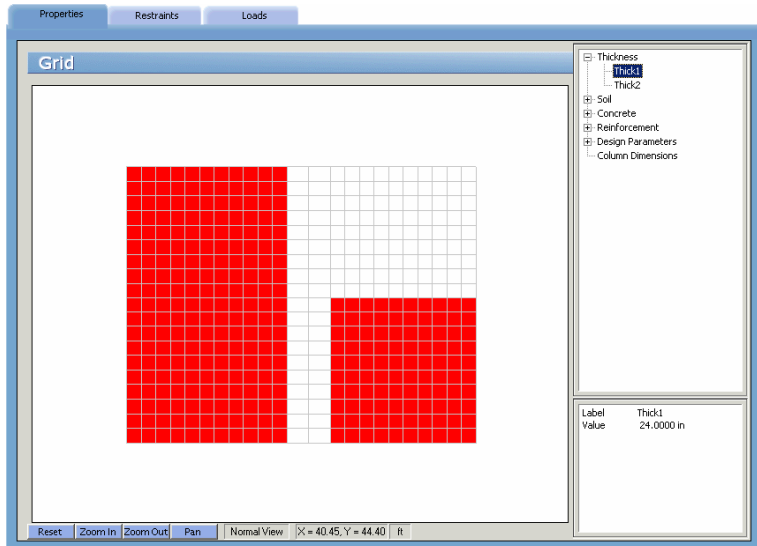

- From the ITEM LISTING AREA, select THICK2. Note that the regions defined in the previous steps are redrawn in cyan, indicating that they have a thickness other than THICK2.
 - In the GRAPHICS/INPUT AREA, marquee-select the region (21,39) – (29, -1) to apply the selected thickness to that part of the footing.
 Note: To see the assigned element and node numbers, from the **Define** menu, select **Grid**, and once the GRID folder surfaces, double click on PREFERENCES.
 - From the **Assign** menu, select **Soil** or click on the SOIL option in the ITEM LISTING AREA.
 - Expand the SOIL listing in the ITEM LISTING AREA and select SOIL1.
 - In the GRAPHICS/INPUT AREA, marquee-select the region (-1,39) – (29, -1) to apply the selected soil to that part of the footing. The selected elements are redrawn in red.
 - Select SOIL2 and in the Graphics / Input Area, marquee-select the region (27,21) – (49, -1) to apply the selected soil to that part of the footing. The selected elements are redrawn in red.
12. From the **Assign** menu, select **Concrete** or click on the CONCRETE option in the ITEM LISTING AREA.
 - Expand the CONCRETE listing in the ITEM LISTING AREA and select CONCL.
 - In the GRAPHICS/INPUT AREA, marquee-select the region (-1,39) – (49, -1) to apply the selected concrete to the entire footing. The selected elements are redrawn in red.
 13. Repeat the step above using the **Assign / Reinforcing Steel and Assign / Design Parameters** commands to apply STEEL1 and DC1 properties to the entire footing.
 14. From the **Assign** menu, select **Slaved Loads** or simply click on the tab to surface the respective folder.
 - In the ITEM LISTING AREA, expand the SLAVED NODES item to display WallRx1 – select it.

- In the GRAPHICS AREA, marquee-select the region (24,25) – (26,15). The five nodes within the selected region are redrawn in red. These nodes are assigned to the slaved nodes group WallRx1.
15. From the **Assign** menu, select **Nodal Loads** or simply click on the tab to surface the respective folder.
- In the ITEM LISTING AREA, expand Case A and then expand CONCENTRATED to select PD1.
 - In the GRAPHICS AREA, click on each of the following nodes (2,2), (25,2), (46,2), (2,18), (46,18), (2,36) and (25,36). Small red squares are shown indicating loaded nodes.
 - Select PD2 from the list box. In the GRAPHICS AREA, click on the nodes (25,16) and (25,24).
 - Select PD3 from the list box. In the GRAPHICS AREA, click on the nodes (25,18), (25,20) and (25,22).
 - In the ITEM LISTING AREA, expand Case B and then expand CONCENTRATED to select PL1.
 - In the GRAPHICS AREA, click on each of the following nodes (2,2), (25,2), (46,2), (2,18), (46,18), (2,36) and (25,36).
 - Select PL2 from the list box. In the GRAPHICS AREA, click on the nodes (25,16) and (25,24).
 - Select PL3 from the list box. In the GRAPHICS AREA, click on the nodes (25,18), (25,20) and (25,22).
 - In the ITEM LISTING AREA, expand Case C and then expand CONCENTRATED to select PW1.
 - In the GRAPHICS AREA, click on each of the following nodes (2,2), (25,2), (46,2), (2,18), (46,18), (2,36) and (25,36).
 - Select PW2 from the list box. In the GRAPHICS AREA, click on the nodes (25,16) and (25,24).
 - Select PW3 from the list box. In the GRAPHICS AREA, click on the nodes (25,18) and (25,22).
 - Select PW4 from the list box. In the GRAPHICS AREA, click on the node (25,20).

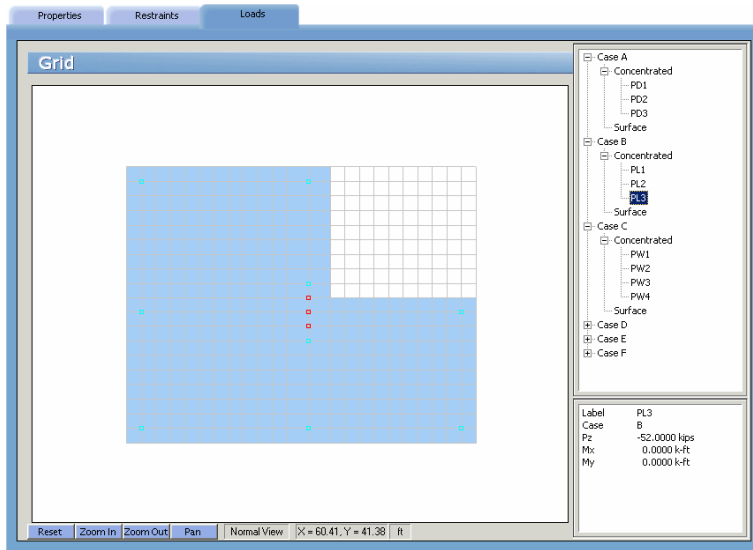

Solving

- From the **Solve** menu, select **Execute** to surface the SOLVER folder...

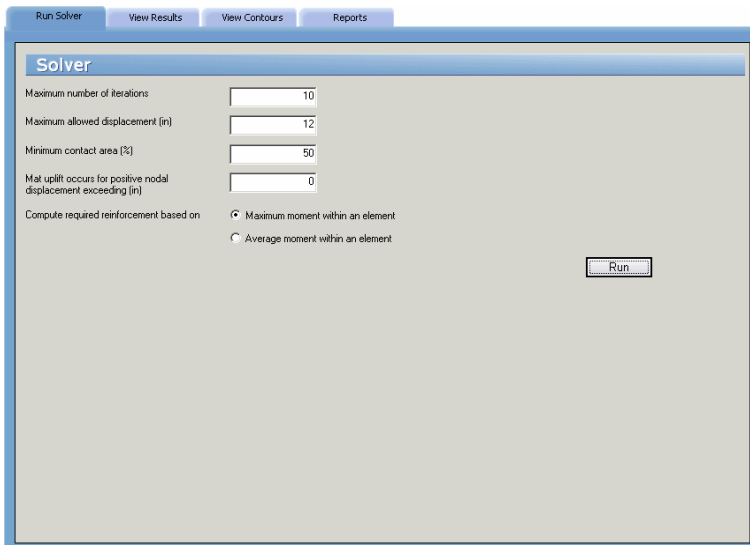

- Enter 10, 12, 50 and 0 in the text boxes and choose the **MAXIMUM MOMENT WITHIN AN ELEMENT** option.
- Click on the **RUN** button.
- The **pcaMats Solver** window is displayed and the solver messages are listed. After the solution is done focus will automatically be passed to the **VIEW RESULTS** folder.

Viewing and Printing Results

- To view the results in text format, use the **Solve / View Results** command. Selective printing may be done from the displayed box or using the **File / Print Results** command.
- To view the results in graphical format, use the **Solve / View Contours** command. A printout of the screen may be obtained using the **File / Print Screen** command.

The screenshot shows the 'View Results' window with the following data:

Envelope - Design Moment & Steel - Bot

C5b - ELEMENT BOTTOM DESIGN MOMENT AND REINFORCEMENT:

Units --> Moment (kip-ft/ft), As (in²/ft)

Flags --> [n] Minimum controls. [x] Exceeds maximum. [*] Cannot compute

Elem	Node	Ld	Comb.	Max. M(ux)	As(ux)	Node	Ld	Comb.	Max. M(uy)	As(y)
1	26	U2		-33.59	0.518m	26	U2		-35.39	0.518m
2	26	U5		-38.21	0.518m	26	U5		-41.09	0.518m
3	3	U5		-13.51	0.518m	27	U2		-21.81	0.518m
4	4	U5		-1.70	0.518m	28	U5		-16.88	0.518m
5	6	-		0.00	0.518m	5	U5		-12.33	0.518m
6	6	-		0.00	0.518m	6	U5		-9.84	0.518m
7	7	-		0.00	0.518m	7	U5		-8.61	0.518m
8	8	-		0.00	0.518m	9	U5		-9.10	0.518m
9	34	U5		-5.00	0.518m	10	U5		-10.26	0.518m
10	35	U5		-11.96	0.518m	10	U5		-10.32	0.518m
11	36	U2		-17.42	0.518m	11	U5		-9.04	0.518m
12	37	U2		-63.99	0.778m	37	U2		-17.80	0.778m
13	37	U2		-68.32	0.778m	37	U2		-21.79	0.778m
14	38	U2		-27.49	0.518m	14	U2		-3.46	0.518m
15	39	U5		-11.88	0.518m	16	U1		-1.57	0.518m
16	40	U1		-2.28	0.518m	16	U1		-1.65	0.518m
17	18	-		0.00	0.518m	18	U5		-2.24	0.518m
18	19	-		0.00	0.518m	19	U5		-3.39	0.518m
19	20	-		0.00	0.518m	20	U5		-5.09	0.518m
20	20	-		0.00	0.518m	21	U5		-7.94	0.518m

Sample Results for Example 2

Appendix

Conversion Factors - English to SI

To convert from	To	Multiply by
in.	m (1000 mm)	0.025400
ft	m	0.304800
lb	N (0.001 kN)	4.448222
kip (1000 lbs)	kN	4.448222
plf (lb/ft)	N/m	14.593904
psi (lb/in. ²)	kPa	6.894757
ksi (kips/in. ²)	MPa	6.894757
psf (lb/ft ²)	N/m ² (Pa)	47.88026
pcf (lb/ft ³)	kg/m ³	16.018460
ft-kips	kN • m	1.355818

Conversion Factors - SI to English.

To convert from	To	Multiply by
m (1000 mm)	in	39.37008
m	ft	3.28084
N (0.001 kN)	lb	0.224809
kN	kip (1000 lbs)	0.224809
kN/m	plf (lb/ft)	68.52601
MPa	psi (lb/in. ²)	145.0377
MPa	ksi (kips/in. ²)	0.145038
kN/m ² (kPa)	psf (lb/ft ²)	20.88555
kg/m ³	pcf (lb/ft ³)	0.062428
kN • m	ft-kips	0.737562

Contact Information

Web Site: <http://www.pcaStructurePoint.com>

E-mail: info@pcaStructurePoint.com
support@pcaStructurePoint.com

Ordering: pcaStructurePoint
Attn: Customer Service
5420 Old Orchard Road
Skokie, IL 60077
USA

Phone: (847) 972-9042

Fax: (847) 972-9043

Technical Support: pcaStructurePoint
5420 Old Orchard Road
Skokie, IL 60077
USA

Phone: (847) 966-HELP / (847) 966-4357

Fax: (847) 581-0644

Bug Report Form

To help us improve our products please fax, mail or e-mail questions to:

pcaStructurePoint
 5420 Old Orchard Road
 Skokie, IL 60077
 Fax: (847) 581-0644
 E-mail: support@pcaStructurePoint.com

Program Name		Company Name	
Program Version		Tester's Name	
Program Release		Phone	
Operating System		Fax	
CPU / Memory		E-mail	
Network		Input File	
Bug No.		Output File	
Date		Screen Shot File	
Bug Priority Category			

Problem Title *Please enter a brief, one-line description of the problem.*

Summary Information *Restate the problem title and/or include more descriptive summary information.*

Error Messages *If the problem causes any error messages, please list the exact error messages that you are receiving.*

Steps to Reproduce *If the problem is reproducible, please list the steps required to cause it. If the problem is not reproducible (only happened once, or occasionally for no apparent reason), please describe the circumstances in which it occurred and the symptoms observed.*

Results *Describe your results and how they differed from what you expected.*

Workaround *If there is a workaround for the problem, please describe it in detail.*

Documentation & Notes *Document any additional information that might be useful in resolving the problem.*

